

The how-to magazine of electronics...

ELECTRONICTM

Service & Technology

MAY 1986/\$2.25

Field strength, or signal-level meter? • Impedance testing methods

The ups and downs of servicing vertical sweep

Test components and ICs with your scope

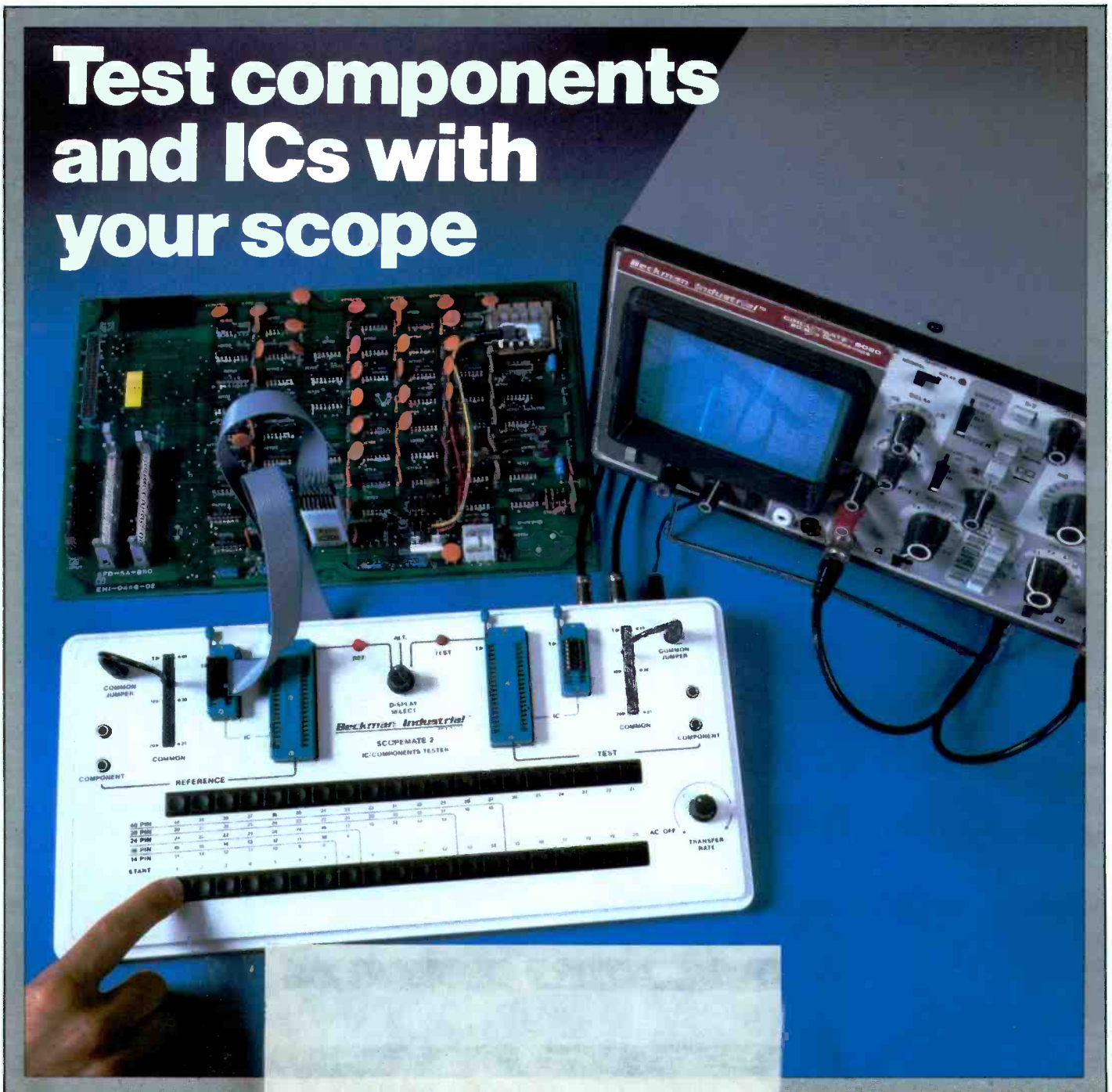

Electricity and water don't mix. At least not in our Heavy Duty Digital Multimeters. Because these Oops Proof™ instruments are protected by a system of seals to ensure contamination-free dependability in even the cruddiest conditions.

Other abuse-proof features include the best mechanical protection ever built into a precision Digital Multimeter. In fact, every one of our Oops Proof multimeters will survive a drop from ten feet onto a concrete surface!

All the Heavy Duty series meters measure up to 1000 volts AC and 1500 volts DC, with full overload protection to those maximum voltages even on the lowest range settings. Overload circuitry also provides transient protection to 6KV on all voltage ranges and up to 600 volts on all resistance ranges.

We also invented a unique, long-life rotary switch for our Digital Multimeters. You can actually feel the difference just by

rotating the function selector knob.

You'll find these features in a full line of Heavy Duty DMMs that offer a 4½ digit readout, 0.05% VDC accuracy, a 10-amp current range, a 2000-hour battery life, diode test, true RMS and temperature measurement. All this and a no-questions, one-year warranty.

You'll want to try one out, of course, so drop into your nearest electronics distributor and drop one.

Our lips are sealed.



© 1985 Beckman Industrial Corporation, A Subsidiary of Emerson Electric Company,
630 Puente Street, Brea, CA 92621 (714) 671-4800.

Beckman Industrial™

Circle (1) on Reply Card

Weller® and Xcelite.® Programmed for advanced servicing.



Xcelite TC100 Attaché Tool Case

The ultimate. Contains 53 individual tools plus 31 interchangeable screwdriver/nutdriver blades and handles. Every one a top quality tool. Don't leave base without it.

Weller/Xcelite 250K Mini Electronic Tool Kit

The best of the basics in a convenient storage case.



Weller GEC120 Electronically Controlled Soldering Gun

Sophisticated high quality tool combines the features of a temperature electronically controlled station with a light-weight easy to handle soldering gun.



Weller DS 600 Portable Desoldering Station

Contains its own vacuum source and only requires a 120 volt supply for complete desoldering capability. Grounded tip prevents damage to sensitive components



Whatever type of computer or electronic equipment you are dealing with, you can be sure to rely on the specialized tools from Weller and Xcelite. A constant program of research and development ensures the most advanced tools capable of servicing the most sophisticated equipment.

Here is a brief specification but check with your Electronics Distributor for the full data.



The difference between work and workmanship.

BOKER® CRESCENT® LUFKIN® NICHOLSON® PLUMB® WELLER® WISS® XCELITE®
The Cooper Group PO Box 728 Apex NC, 27502 USA Tel (919) 362-7510 Telex 579497

12

The ups and downs of servicing vertical sweep

By Homer L. Davidson

Certain vertical problems reappear almost predictably because of design elements in certain TV sets. Ten such sets, ten such problems are diagnosed, discussed and the "treatment" described in this article by a well-known electronics writer.

23

Test your electronic knowledge

By Sam Wilson

We're betting our subscribers know how flyback amplitudes relate to sophisticated shutdown circuits employed in modern color receivers. Or, what is dissolved in a positive liquid crystal matrix of a GHM LCD? Enjoy this quiz, anyway; there may be some surprises.

24

Field-strength meter or signal-level meter?

By James F. Kluge

"Field-strength" meter is a misnomer often used when "signal-level" meter (commonly intended for measuring relative signal levels throughout an MATV/CATV system) is the correct term.



page 26

Device malfunctions are more speedily spotted when an add-on test module is used in conjunction with any dual-trace oscilloscope.

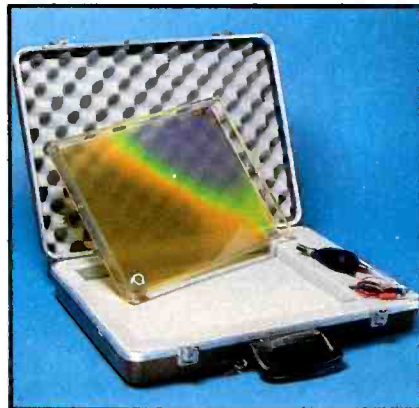

page 8

In an electronic circuit, a change in temperature foretells trouble; now, hot spots can be profiled—in color—on a new LCD film.

Departments:

- 4 Editorial
- 6 News
- 8 Technology
- 29 Profax
- 43 Literature
- 53 Books
- 57 Photofact
- 58 Products
- 61 Reader's Exchange
- 62 Symcure

26

Test components and ICs with your scope

By Al Kovalsky

An inexpensive add-on test module permits comparison testing with your oscilloscope, extending its usefulness, and eliminating tedious "one-potato, two-potato" procedures.

45

Impedance testing methods

By Gregory D. Carey, CET

Capacitors and inductors are passive components that, ideally, test with insignificant variations. So, where is the difficulty? Non-ideal conditions and an idiosyncrasy of these components may create unexpected difficulties.

54

What do you know about electronics? – Visual modulation

By Sam Wilson

Today, complex waveforms are being converted into digital equivalents for the new all-digital audio and TV systems. This article was written to encourage those technicians who are not already doing so to visualize waveforms in 3-D, adding a third dimension to the usual 2-dimensional display.

Save 10% and more!*

6 ways to take the trouble out of troubleshooting

When you need fast and accurate answers to your most complex troubleshooting questions, turn to these best-selling reference manuals from Prentice-Hall. They'll help you zoom through the toughest troubleshooting tasks — even when manufacturers' service data isn't available.

Now you can bench-test any of these time- and work-saving reference manuals for 15 days absolutely FREE. There's no obligation to buy...no future commitments of any kind. Just a chance for you to see for yourself — at our expense — how easy troubleshooting can actually be.



Buchsbaum's Complete Handbook of Practical Electronic Reference Data, Second Edition

By Walter A. Buchsbaum, Sc. D.

Completely revised and updated, this handbook provides you with 402 tables, drawings, schematics, charts, and graphs so you can quickly and easily answer any question in every major area of electronics. From the factual foundations of all electronics to the latest technical advances in opto-electronics, large-scale integrated circuits, computers, and programming languages, you have all you need to save hours of calculations and analysis. **\$34.95**



Illustrated Encyclopedic Dictionary of Electronics

By John Douglas-Young

Quickly and easily find concise definitions and detailed illustrations for thousands of electronic terms and concepts—everything from Charge-Coupled Devices and Interdigital Transducers to Bubble Memories and Magnetic Amplifiers. This handy workbench tool is arranged in easy-to-use dictionary form. You get mathematical tables, reference charts, conversion factors, preferred values, electrical equations and formulas to help you solve the toughest technical problems. **\$39.95**

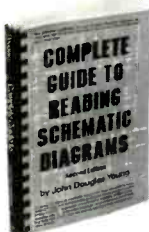

Complete Guide to Reading Schematic Diagrams, Second Edition

By John Douglas-Young

Over 175,000 technicians use this manual to take the guesswork out of reading schematic diagrams. Packed with step-by-step explanations of the 200 most commonly-used electronic circuits, you get updated information on solid state and integrated circuits...complete coverage of demodulators...and the "Circuit Analyzer" which helps you instantly identify and diagnose circuit troubles in power amplifiers, oscillators, mixers, converters, and other electronic devices. **\$24.95**



Practical Guide to Digital Integrated Circuits, Second Edition

By Alfred W. Barber

This time-saving workbench guide shows you step-by-step how to build your own testers for troubleshooting IC devices quickly and easily...develop complex systems using simple basic elements...interpret a manufacturer's spec sheet without being misled by incomplete data. You also get scores of invaluable work-saving aids, shortcuts and professional tricks of the trade for testing and troubleshooting today's wide range of digital integrated circuits. **\$24.95**



Electronic Servicing Data & Procedures: A Complete Manual and Guide

By Robert C. Genn, Jr.

This one-of-a-kind service manual contains nearly 200 tests that cover the spectrum of electronic servicing problems, including audio equipment...linear and analog circuitry...radio frequency equipment...high frequency transistor circuits...and more. This massive collection of service-related reference data contains everything you need to speed up your servicing and solve problems that stump experts. **\$29.95**

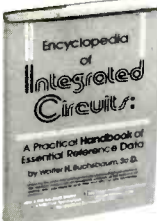

Encyclopedia of Integrated Circuits: A Practical Handbook of Essential Reference Data

By Walter A. Buchsbaum, Sc. D.

Now you can design, test, repair, and troubleshoot integrated circuits without wading through endless specification tables and other non-essential manufacturers' data. Covering the entire range of ICs from analog to interface — from the user's viewpoint — this handbook provides over 1,000 cross-referenced tips, suggestions, and shortcuts to help you save hours of valuable time and effort on your next project. **\$34.95**

PRENTICE-HALL, INC. Business and Professional Division
Englewood Cliffs, NJ 07632

Fill in and mail to Prentice-Hall, Inc. Book Distribution Center, Route 59 at Brookhill Drive, West Nyack, NY 10095

SAVE — I prefer to send payment plus local sales tax now and save 10% off the list price for each book I order. What's more, Prentice-Hall will pay all postage and handling charges. Same return privilege, full money-back guarantee.

YES, send me the book(s), I've checked for a free 15-day trial examination. After 15 days, I will either honor your invoice for the list price, plus postage and handling, or return the book(s) and pay nothing, owe nothing.

Name Mr./Ms. _____
 Firm _____
 Address _____
 City/State/Zip _____
 Dept. 4 _____ S6019-Z1 (9)

Complete Guide to Reading Schematic Diagrams, 2nd Edition (160416) \$24.95
 Encyclopedia of Integrated Circuits: A Practical Handbook of Essential Reference Data (275875) \$34.95
 Buchsbaum's Complete Handbook of Practical Electronic Reference Data, 2nd Edition (084624) \$34.95
 Practical Guide to Digital Integrated Circuits, 2nd Edition (690750) \$24.95
 Illustrated Encyclopedic Dictionary of Electronics (450791) \$39.95
 Electronic Servicing Data and Procedures: A Complete Manual and Guide (251850) \$29.95

Note: Please send 25% partial payment with orders over \$100.

Circle (4) on Reply Card

Using the right tool for the job

If you watch carefully as an artist paints a picture, you will probably notice that he makes most of his strokes with one type of brush. For special flourishes he'll bring out a special brush, perhaps a fan brush, or some other tool, maybe a palette knife.

It's the same with most professions or skills: One tool or type of tool suffices to do most of the work, but when something special has to be done, it calls for a less often used, perhaps less understood tool. A skilled woodworker, for example, might ordinarily use a dado blade to cut rabbets into furniture, but on occasion the dado might cut too fast, or for some other reason not be appropriate. In such a case, he might bring out the router, or even the backsaw and a chisel.

The same is true with electronics servicing. Most experienced technicians perform their diagnostic routines in the same way, usually with the same tools. A typical approach is to set up the DMM and perhaps take a few resistance readings to see if the problem was caused by a short circuit somewhere, or possibly an open circuit. If those checks don't reveal anything, the next step might be to turn on the unit under test and take some quick voltage readings.

If the resistance and voltage checks don't turn up anything, the next step is frequently to fire up the oscilloscope and have a look at a few waveforms.

All of this is as it should be. Artists use brushes they're most familiar with and the results of which they can predict. Woodworkers use the tools that are most productive and with which they're most familiar because they know how the piece will turn out when they use them. Technicians begin a diagnosis with the tools that are simplest to use and interpret, and with which they are comfortable. Having a few such tools makes sense because familiarity with the tools leads to efficiency, effectiveness and accurate results for any artist, craftsman or skilled worker.

If there is efficiency and accuracy in consistently following a set routine using a small set of familiar tools, there is a danger as well. The habit becomes ingrained, and alternative procedures and equipment that might yield more effective results in unusual cases are not considered.

Because this is a possibility, we have put this issue together. Presented here are articles that detail some diagnostic procedures using less frequently used test equipment: field-strength meters, signal-level meters, impedance meters, curve tracers. Testing devices such as these are ordinarily not among those that technicians reach for automatically when they are presented with a problem. This is as it should be, because these tools are specialized devices for specialized uses. But when the problem at hand would most effectively be solved with one of these units, it would be unfortunate if unfamiliarity with the equipment caused it to be overlooked.

Information, please...

Things are changing rapidly in electronic servicing, just as they are in the rest of the world. That means that **Electronic Servicing & Technology** has to change in order to keep up. Please help us make sure that we're changing in the right direction by letting us know who you are and what you're doing.

Inside the front cover of this issue of **ES&T** is a survey-type card that asks four questions: the type of business you're in; your position; the number of service technicians employed at your facility; and your role in purchasing electronics servicing equipment.

If you will take just one minute to fill in the requested information and check the appropriate boxes, it will help us immensely in planning future articles and other information to be published in **ES&T** that will be of the most benefit to you.

Thanks.

Nils Conrad Pearson

Put a test lab in your tool pouch.

The Fluke 8060A 4½-digit handheld multimeter.

It's the best tool you could add to your tool pouch, because it lets you troubleshoot more ... with less.

This portable, powerful instrument has a unique combination of features not available in any other handheld DMM. It lets you reach beyond traditional DMM applications, tackling jobs that often require more equipment than you can carry.

A simple push of a button on the Fluke 8060A lets you measure frequencies to 200 kHz, make relative offset measurements, convert voltages to direct reading decibels, or conduct audible continuity tests. Plus the 8060A offers wideband True RMS ac measurement capability to 100 kHz.

So say goodbye to your part-time counters, oscilloscopes, continuity testers, calculators and power supplies. And welcome a full-time professional that'll be there when you need it.

You'll find that for troubleshooting everything from motor controls to data communications equipment, the Fluke 8060A is the best multimeter value going.

Find out more by calling our toll-free hotline **1-800-227-3800, ext. 229**, day or night. Outside the U.S. call 1-402-496-1350, ext. 229.

FROM THE WORLD LEADER
IN DIGITAL MULTIMETERS.

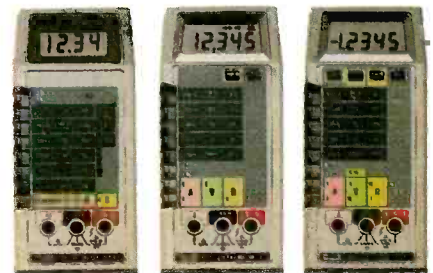

8026B

\$199*
0.1% basic dc accuracy
1999 count display
True-rms ac voltage to 10 kHz
True-rms ac current
Continuity and diode test
Relative reference
One-year calibration cycle and two-year warranty

8062A

\$279*
.05% basic dc accuracy
19999 count display
True-rms ac voltage and current
Continuity and diode test
Relative reference
One-year calibration cycle and warranty

8060A

\$349*
0.4% basic dc accuracy
19999 count display
True-rms ac voltage and current
Continuity and diode test
Frequency measurements
dBm, Relative dB
Relative reference
One-year calibration cycle and warranty

* Suggested U.S. list price, effective January 1, 1986



IN THE U.S. AND NON-EUROPEAN COUNTRIES: John Fluke Mfg. Co., Inc. P.O. Box C9090, M/S 250C, Everett, WA 98206, Sales (206) 356-5400, Other (206) 347-6100
EUROPEAN HEADQUARTERS: Fluke (Holland) B.V., P.O. Box 2269, 5600 CG Eindhoven, The Netherlands, (040) 458045, TLX: 51846.
© Copyright 1985 John Fluke Mfg. Co., Inc. All rights reserved. Ad No. 4703-8060

Circle (5) on Reply Card

Confusion over CET examinations

Instructors and technicians need to be aware that organizations other than the International Society of Certified Electronics Technicians are offering certificates labeled CET.

At the Consumer Electronics Show in Las Vegas, NV, representatives in the ISCET booth were questioned by two instructors who claimed to have sent money to ISCET to become authorized test administrators. Apparently their money was sent to another organization that encourages certification without testing for a \$25 fee and offers an option to earn money as a test administrator.

In the 20 years of certifying technicians, ISCET has never required a fee for examiners. ISCET has no knowledge of what quality exam is being offered or who may be recognizing the exam. The alleged organization has no listing in the Encyclopedia of Association or in the National Directory of Trade and Professional Associations of The United States. It is not on the list of organizations

listed by the FCC as offering certificates to replace FCC licensing.

Another area of confusion for technicians deals with the "CET Exam Book" by Dick Glass and Ron Crow, published by TAB. There have been several instances where students have contacted the national ISCET office concerning this book. Referring to the examiners list offered in the back of the book, students have taken the exam offered by ETA-I, mistaking it for the ISCET exam.

The United States Copyright office has stated that the CET exam can be offered by any organization, just as any university program can offer a B.A. degree. Persons are urged when using the letters CET to be sure that technicians clearly understand whether the CET is recognized by ISCET.

For more information about CET examinations, contact ISCET offices at 2708 West Berry St., Fort Worth, TX 76109; 817-921-9101.

NESDA House passes parts resolution

A resolution targeted at manufacturers' billing procedures for warranty parts was passed at the January midyear meeting of the National Electronics Sales and Service Dealers Association House of Representatives.

As parts for electronic products

have increased in both complexity and price, independent servicers have been required to maintain more expensive inventories to service the newer products.

Because manufacturers normally bill servicers for all parts, and then issue credit for warranty parts, many dealers have developed a severe cash flow problem in carrying warranty work while waiting for credit and labor reimbursement.

The NESDA house passed unanimously this resolution:

Whereas increased costs of major components used in advanced products and delays in processing credits to offset the cost of these parts used in warranty repairs have caused severe imbalances in current parts accounts, resulting in situations where service centers are subsidizing warrantors, be it therefore resolved that warrantors whose internal procedures require longer than 30 days to issue credit for parts used in warranty repairs should provide such parts on memo billing or delay billing to match their cycle of processing parts credits.

NESDA urges service dealers and manufacturers to respond to this resolution.

For more information about NESDA, contact Clyde Nabors 817-921-9101.

ELECTRONIC

Servicing & Technology

Editorial, advertising and circulation correspondence should be addressed to: P.O. Box 12901, Overland Park, KS 66212-9981 (a suburb of Kansas City, MO); (913) 888-4664.

EDITORIAL

Nils Conrad Persson, *Editor*
 Carl Babcoke, *Consumer Servicing Consultant*
 Dan Torchia, *Group Managing Editor*
 Marjorie Riggan, *Associate Editor*
 Joy Culver, *Editorial Assistant*
 Darryll Fortune, *Editorial Assistant*
 Sondra D. Williams, *Editorial Assistant*

CONSULTING EDITORS

Homer L. Davidson
 Christopher H. Fenton
 Bud Izen
 Victor Meeldijk
 Kirk G. Vistain
 Sam Wilson

ART

Kevin Callahan, *Art Director*
 Tim Lynch, *Graphic Designer*

BUSINESS

Cameron Bishop, *Group Vice President*
 Eric Jacobson, *Publisher*
 Greg Garrison, *Sales Manager*
 Stephanie Fagan, *Promotions Manager*
 Kelly Hawthorne, *Marketing Assistant*
 Dee Unger, *Advertising Supervisor*
 Karen Royall, *Advertising Coordinator*

ADMINISTRATION

R. J. Hancock, *President*
 John C. Arnst, *Circulation Director*
 Jo Ann DeSmet, *Circulation Manager*
 Dee Manies, *Reader Correspondent*



Member, Audit Bureau of Circulation



Member, American Business Press



Member, Electronic Servicing Dealers Association

ELECTRONIC SERVICING & TECHNOLOGY is the "how-to" magazine of electronics. It is edited for electronic professionals and enthusiasts who are interested in buying, building, installing and repairing consumer electronic equipment. This includes audio and video equipment, microcomputers and electronic games.

SUBSCRIPTION PRICES: one year \$18, two years \$30, three years \$38 in the USA and its possessions. Foreign countries: one year \$22, two years \$34, three years \$44. Single copy price \$2.25; back copies \$3.00. Adjustment necessitated by subscription termination to single copy rate. Allow 6 to 8 weeks delivery for change of address. Allow 6 to 8 weeks for new subscriptions.

PHOTOCOPY RIGHTS: Permission to photocopy for internal or personal use is granted by Intertec Publishing Corp. for libraries and others registered with Copyright Clearance Center (CCC), provided the base fee of \$2 per copy of article is paid directly to CCC, 21 Congress St., Salem, MA 01970. Special requests should be addressed to Eric Jacobson, publisher.
 ISSN 0278-9922 \$2.00 + 0.00



©1986 All rights reserved.



In less time than it took you to read just the first ten words of this sentence - - -

You could have diagnosed any problem, in any brand, solid state TV set down to circuit level, with 100% accuracy.

By simply plugging the set's AC cord into a self programming Mark VII computer, pushing one test button, and noticing which one of sixty lights are lit.

The light that is lit tells you which circuit or stage is not functional.

In nine out of ten instances, you can do so without even removing the back of the TV set! (Talk about fast estimates)

— INTERMITTENTS —
NO PROBLEM WHATEVER !

Leave the TV set's AC cord plugged into your Mark VII, leave the computer turned on, and go home for the weekend!

As soon as the set shuts down, or otherwise fails, the Mark VII will "Zero In" on **why** it failed, lite and latch the proper indicator light, automatically turn itself and the TV set off, then, sit there idle (with one light lit) awaiting your return.

All this by just plugging in the AC cord.
No other connections are required.

(In certain cases of low end, LV regulator shut down, you may have to bridge the LV regulator with an LV rect. other than this occasional inconvenience, no other connections are required. An adapter plug is provided for such instances.)

With a Mark VII you could accurately diagnose 400 TV sets down to circuit level in one 8 hour day. Unfortunately, you won't be able to replace the defective parts that quickly!

DIEHL

Call (806) 359-0329 for more info

6661 Canyon Dr. • Amarillo, TX 79110

LCD film pinpoints short circuits

One of the symptoms of a fault in an electronic circuit is a change in temperature. If a component or length of conductor becomes open circuited, current stops and that portion of the circuit operates cooler than normal. If, on the other hand, there's a short circuit, more current than normal will be drawn and the temperature of the portion of the circuit through which the excessive current flows will be higher than normal.

Many astute technicians take advantage of this in their diagnosis by feeling components or circuit board areas (first making sure there are no dangerous voltages present) to determine if an area is cooler or hotter than it should be.

Modern LCD technology has resulted in test equipment that gives a visual indication of hot spots caused by short circuits.

Short scan

Short Scan is a product advancement in liquid crystal technology. Liquid crystals have been dispersed into a polymer system to provide a tough, yet elastic film. The development of this film provides low-cost thermal profiling capabilities previously available only in expensive infrared camera systems.

The liquid crystals display a color-to-temperature relationship. As the temperature changes, so does the color, as long as the

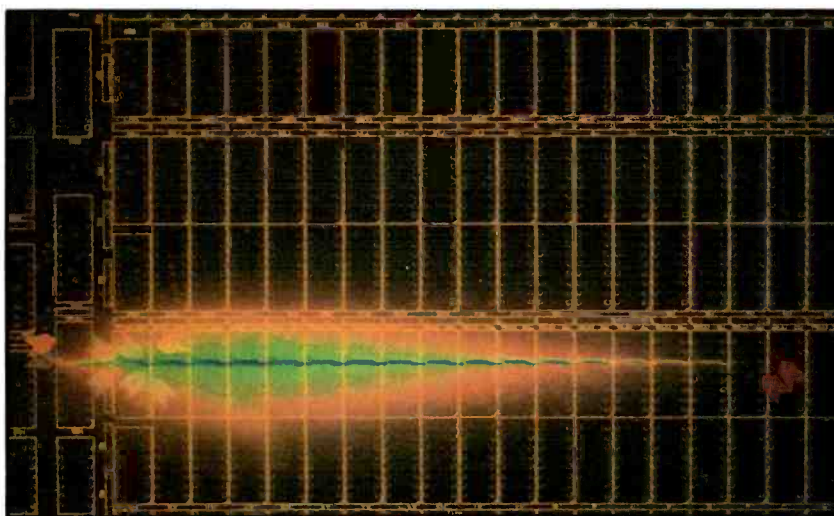

The thin bluish line shown here looking like a comet's tail is an indication on the Short Scan of current through a short circuit on a printed circuit board.

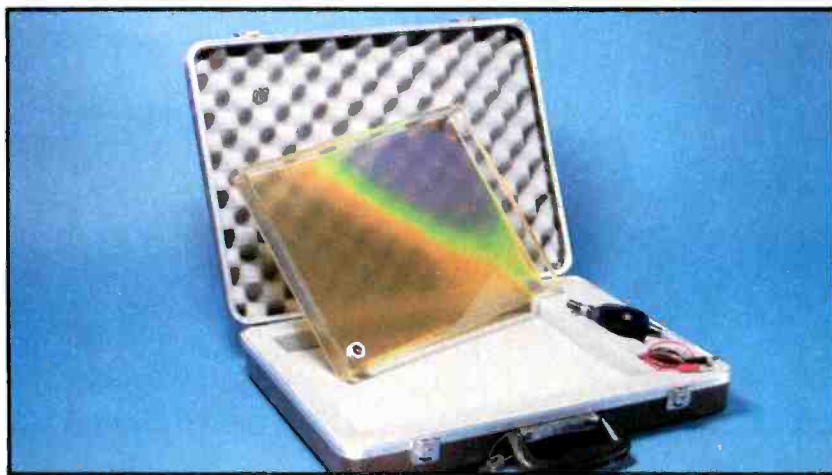

Thermal imaging film is furnished with an air pump to inflate if necessary in order to make it conform better to the unit being checked.

temperature is within the color range of the liquid crystals. As the temperature increases within the color range, the color will always shift toward the violet. Short Scan liquid crystals are reversible and as the temperature decreases within the color range, the color will shift toward the red.

Thermal profiling

The pattern of heat dissipation from an object (its thermal profile) nearly always provides important information about the operating condition or status of the object. The object may be a populated printed circuit board (PCB) or it may be a special heat exchanger.

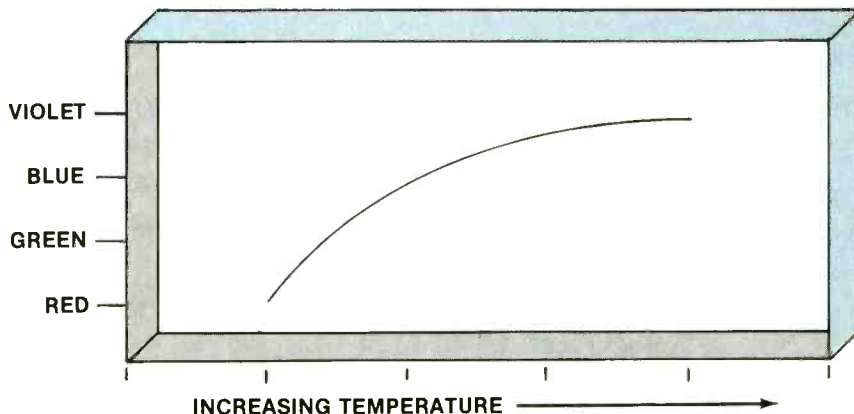

Figure 1. As the temperature increases, the color of the film will shift toward violet. As temperature decreases, it will shift toward red.

ADVERTISEMENT

— NOTICE —

If your company is confronted with troubleshooting or otherwise repairing a certain type, or piece of equipment on a frequent basis - - -

i.e. TV sets, VCR's, Electronic Cameras, Copy Machines, Amplifiers, Industrial Controls, Answering Machines, Radios, Robotics, Bio Medical, Military, Avionics, etc., etc., etc., - - -

The odds are staggering that we could custom program one of our Mark VII computers to accurately isolate any failure in any such device (down to circuit level) in less than two seconds!

INTERMITTENTS POSE NO PROBLEM

(See our display ad on page 21)

DIEHL

6661 Canyon Drive • Amarillo, TX 79110

ADVERTISEMENT

Each has a thermal profile specific to itself when functioning correctly. One of these films will image the thermal profile, and a Polaroid camera can be used to capture the thermal profile as a permanent record.

Operating ranges

It is important to understand that the operating color temperature range is not the same as the temperature range over which it is useful. Pressing an LCD film momentarily against a hot surface will provide a thermal map of the

warmest-to-coolest areas on the basis of time. That is, the warmest areas will change the color first through the red-to-blue sequence. Cooler areas will follow on the relative basis of their temperature to the temperature of the area that first gave a color change. Then, the next warmest areas will change color second, and other less warm areas will follow with increasing time.

Electronics

With shorts on bare boards, a variable current supply is con-

nected to the shorted points from the underside of the board. As the current is raised, heat is generated in the shorted area causing a corresponding color change in the film. Because the film is transparent, the exact location of the short may be viewed.

In testing loaded boards, the board can be functionally operating. With the board looping on the failed-test sequence, you would plate the film on the circuit board. The shorted area is indicated by a color change.

(V)SRAM joins the DRAM

A prototype of the world's first 1M SRAM (static random access memory) semiconductor chip has been developed by Toshiba, on the heels of Toshiba's DRAM chip, also one megabit, that was acclaimed as "Faster than a speeding bullet..." just last year. (See **ELECTRONIC SERVICING & TECHNOLOGY**, July 1985.)

The major difference between the two ultra-speedy accessing chips involves the way that the refresh operation is handled. With Toshiba's new chip, the refresh operation is inserted into intervals between normal operations, leav-

ing users completely unaware that such an operation is being carried out. In the DRAM operation, if the line is "busy," normal operation is delayed until the refresh operation ends. Using DRAM, a computer manufacturer must employ devices like a refresh controller and an address multiplexer *outside* the chip in order to keep stored data from vanishing. The new (V)SRAM already has function circuits integrated directly onto the chip to perform the refresh operation automatically. No added circuit is necessary.

This latest chip was designated

VSRAM (virtual SRAM) because of its unique characteristics. Conventional SRAMs require between four and six transistors to form a memory cell, while DRAMs use a transistor and a capacitor. (One bit, the basic unit of information, is stored in each memory cell.) Like a DRAM, the VSRAM employs a transistor and a capacitor. By combining 1.0 μ m lithographic technology and advanced CMOS (complementary metal oxide semiconductor) technology, Toshiba incorporated the approximately 2.2 million memory elements with the necessary refreshing circuits. All this on a silicon chip measuring 5.99mm x 13.8mm. Access time: 62ns, or billionths of a second.

Toshiba is developing a suitable, practical method for mass producing the VSRAM.

ES&T

Comparison between DRAM and SRAM refreshing system

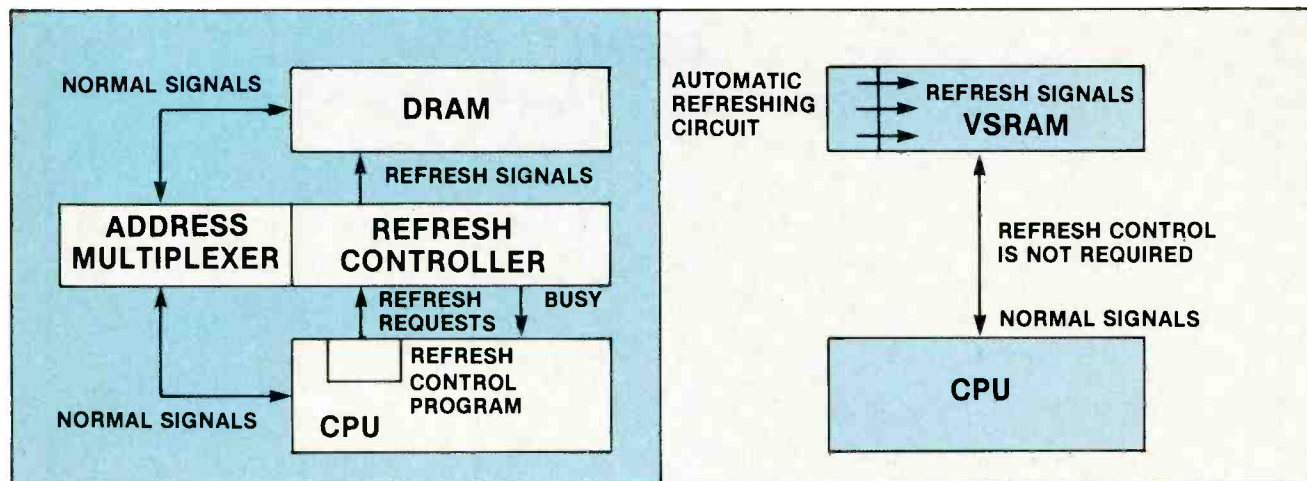

Figure 4. DRAM: If the line is busy, normal operation is delayed until the refresh operation ends.

VSRAM: Because the refresh operation is inserted into intervals between normal operations, users are completely unaware that the refresh operation is being carried out. A VSRAM can be connected directly to a CPU without peripheral chips.

WARRANTY WORK

When you compare time spent to pay received, you might find it difficult to survive on some of the warranty allowances in today's market.

If so, this ad will serve as a reminder - - -

In less time than it takes you to print the customer's name on a warranty tag, a Mark VII computer will diagnose the failure down to circuit level. In most cases it will do so - - - without even removing the back!

If your local factory field service representative says it can't be done, remind him that **Diehl** will pay any engineer / technician a year's wages who can troubleshoot just three of his most familiar TV sets, before a Mark VII can troubleshoot thirty!! Hopefully, this challenge will either cause him to take his foot out of his mouth, - - - or finish putting it in!

— INTERMITTENTS POSE NO PROBLEMS —

(See our display ad on page 21)

DIEHL

Call (806) 359-0329 for more info.

6661 Canyon Drive • Amarillo, TX 79110

The Ups and Downs of Servicing Vertical Sweep

Vertical-deflection systems are second only to the horizontal-sweep systems in the number of failures and service problems. These 10 examples show the wide variety of malfunctions that can (and do) occur in the vertical-deflection sections of several color-TV-receiver brands.

By Homer L. Davidson

Vertical-deflection circuits can appear to violate some laws of electronics. For example, the output waveform of a transistor stage might be completely different from the input waveform during correct operation. One possible explanation is that deflection yokes (both horizontal and vertical) operate principally from current, while a resistance-coupled stage operates with a voltage signal. Therefore, the dividing line between voltage and current amplification produces large scope waveform changes. Also, transistors operated in class C account for other differences.

All oscillators need positive feedback to maintain steady operation. Technicians need to know how to recognize the feedback source; if it is missing, the oscillator is dead. Older solid-state receivers often used two or more transistors in the vertical-oscillator circuit, with positive feedback taken from one to the other. With integrated circuits, the source of the feedback probably is within the IC and is not accessible for tests. A few vertical circuits take a sample through resistors of the vertical yoke's voltage signal and apply it to the oscillator. Whatever the circuit, loss of positive feedback eliminates the vertical-oscillator operation and with it the vertical deflection. Of course, count-down models obtain a vertical signal by counting down from the horizontal, so they do not have an oscillator in the usual sense. A *vertical-drive* signal can be emitted even when the following vertical circuit is completely dead.

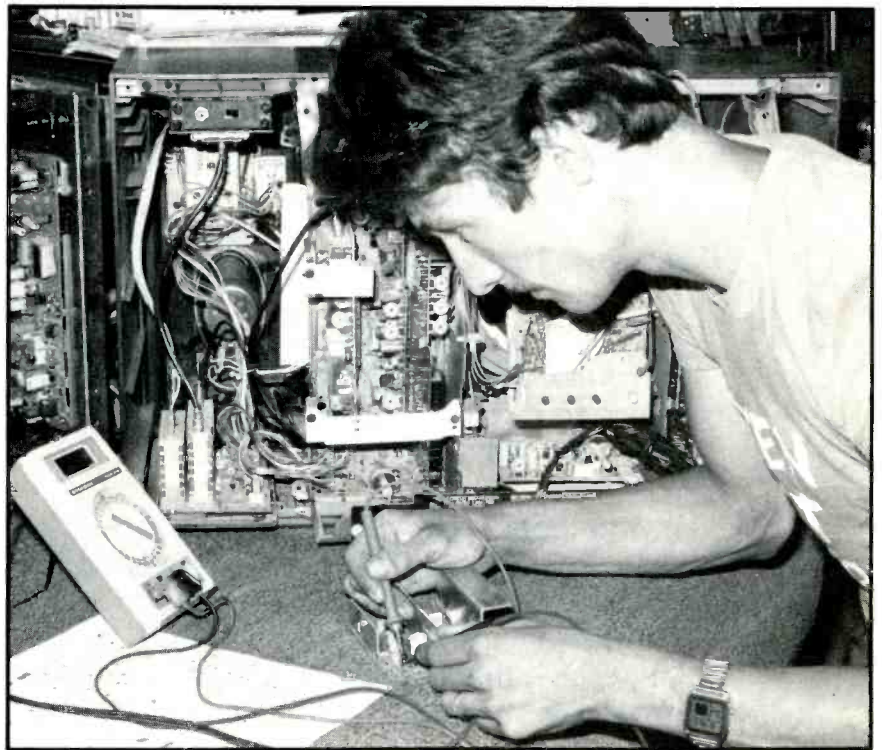

After they are removed, plug-in panels or modules can be checked for continuity and resistance values. As shown, diode and transistor junctions can be checked for forward voltage drop and reverse leakage by using any digital multimeter that has such a test. These readings can be fast and very helpful, but the accuracy decreases when the circuits parallel low-value resistances across the junctions. Out-of-circuit tests after component removal are recommended in these cases.

Next is the question of picture height. A total lack of height (zero vertical deflection) produces a single, bright and narrow horizontal line across the center of the raster. Insufficient deflection reduces the picture height until it is not tall enough to fill the screen. But the screen can be covered with non-linear deflection. The vertical yoke current *should be* almost a perfect sawtooth waveshape. However, when you're troubleshooting, it is faster and more ac-

curate to use a cross-hatch generator and adjust the linearity control (if there is one) or make repairs until the cross-hatch horizontal bars are equally spaced, rather than judge by the yoke sawtooth.

Allied with the vertical-deflection system are the various horizontal dark or light bars across the screen that either are stationary or move upward slowly. These bars can have rounded edges (sine waves, perhaps from

CIE CATALOG

Rush me CIE's COLOR CATALOG with complete details on electronics independent study. I understand there is no obligation. For your convenience, CIE will try to have a representative contact you — there is no obligation.

Name _____
(Please Print)

Address _____ Apt. _____

City _____ State _____ Zip _____

Age _____ Phone (area code) _____ / _____

Check Box For G.I. Bill Information: Veteran Active Duty

AES06

ES&T

Detach and Mail This Postage-Paid Card Today



NO POSTAGE
NECESSARY
IF MAILED
IN THE
UNITED STATES

BUSINESS REPLY MAIL

FIRST CLASS PERMIT NO. 8685 CLEVELAND, OHIO

POSTAGE WILL BE PAID BY ADDRESSEE

CIE

Cleveland Institute of Electronics, Inc.

1776 East 17th Street
Cleveland, Ohio 44114



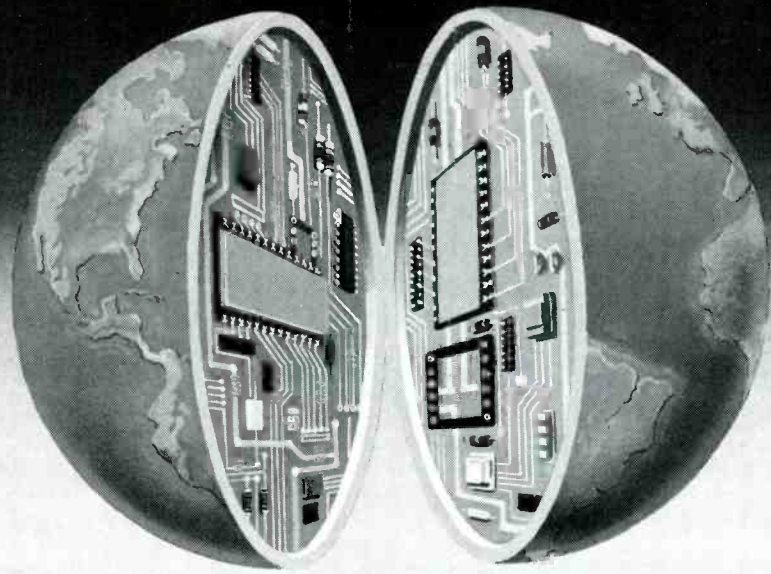

CIE MAKES THE WORLD OF ELECTRONICS YOURS.

Today's world is the world of electronics. But to be a part of it, you need the right kind of training, the kind you get from CIE, the kind that can take you to a fast growing career in business, medicine, science, government, aerospace, communications, and more.

Specialized training.

You learn best from a specialist, and that's CIE. We're the leader in teaching electronics through independent study, we teach only electronics and we've been doing it for over 50 years. You can put that experience to work for you just like more than 25,000 CIE students are currently doing all around the world.

Practical training.

You learn best with practical training, so CIE's Auto-Programmed® lessons are designed to take you step-by-step, principle-by-principle. You also get valuable hands-on experience at every stage with sophisticated electronics tools CIE-designed for teaching. Our

4K RAM Microprocessor Training Laboratory, for example, trains you to work with a broad range of computers in a way that working with a single, stock computer simply can't.

Personalized training.

You learn best with flexible training, so we let you choose from a broad range of courses. You start with what you know, a little or a lot, and you go wherever you want, as far as you want. With CIE, you

can even earn your Associate in Applied Science Degree in Electronics Engineering Technology. Of course, you set your own pace, and, if you ever have questions or problems, our instructors are only a toll-free phone call away.

The first step is yours.

To find out more, mail in the coupon below. Or, if you prefer, call toll-free 1-800-321-2155 (in Ohio, 1-800-523-9109). We'll send you a copy of CIE's school catalog and a complete package of enrollment information. For your convenience, we'll try to have a representative contact you to answer your questions.



ES-05

CIE Cleveland Institute of Electronics

1776 East 17th St., Cleveland, Ohio 44114

YES! I want to get started. Send me my CIE school catalog including details about the Associate Degree Program. I am most interested in:

- | | |
|--|---|
| <input type="checkbox"/> computer repair | <input type="checkbox"/> television/high fidelity service |
| <input type="checkbox"/> telecommunications | <input type="checkbox"/> medical electronics |
| <input type="checkbox"/> robotics/automation | <input type="checkbox"/> broadcast engineering |
| <input type="checkbox"/> other _____ | |

Print Name _____

Address _____ Apt. _____

City _____ State _____ Zip _____

Age _____ Area Code/Phone No. _____

Check box for G.I. Bulletin on Educational Benefits

- Veteran Active Duty

MAIL TODAY!

OR CALL TOLL FREE 1-800-321-2155 (In Ohio, 1-800-523-9109)

Circle (7) on Reply Card

60Hz or 120Hz power supplies) or sharp edges (pulses or square waves from vertical-sweep circuit) when a defect allows some of the waveform to enter the video circuit and thus reach the picture tube. No examples of these bars are given in the 10 problems because they have no effect on height or linearity.

Test equipment requirements are moderate. The following are recommended:

- an accurate digital multimeter (DMM), preferably with a voltage-drop diode test;
- a transistor tester for in-circuit and out-of-circuit indications;
- a dual-trace scope (does not require wide bandwidth);
- a digital-readout capacitance meter.

Some digital multimeters have a transistor-junction and diode test that applies a constant current to the junction and measures the resulting voltage drop across that junction. Overrange of the meter indicates the junction is open or the probes have been connected backwards, applying the incorrect polarity to the junction. Many tests of transistor junctions can be made in-circuit with acceptable accuracy, provided the circuit resistances are not lower than 1,000Ω or so. The conventional ohmmeter ranges are used for leakage tests. This diode/transistor-junction test does not measure transistor gain, so it is not a complete substitute for a true transistor tester. It is a test that can be done rapidly and yet find an amazing number of bad junctions.

With adequate test equipment and all necessary Photofact schematics, we are ready to troubleshoot 10 examples of vertical-deflection problems.

JCPenney with no height

Only a single white horizontal line was on the screen of a JC Penney model 605-1723 (Photofact 1650-1). I used a scope to trace the vertical signal to the base of Q208 (Figure 1), but no waveform was found at the Q208 collector or any other point downstream toward the yoke. Obviously, the problem was with the Q208 or the Q210 stage. DMM dc-voltage measurements of the two transistors showed the same +20.1V reading

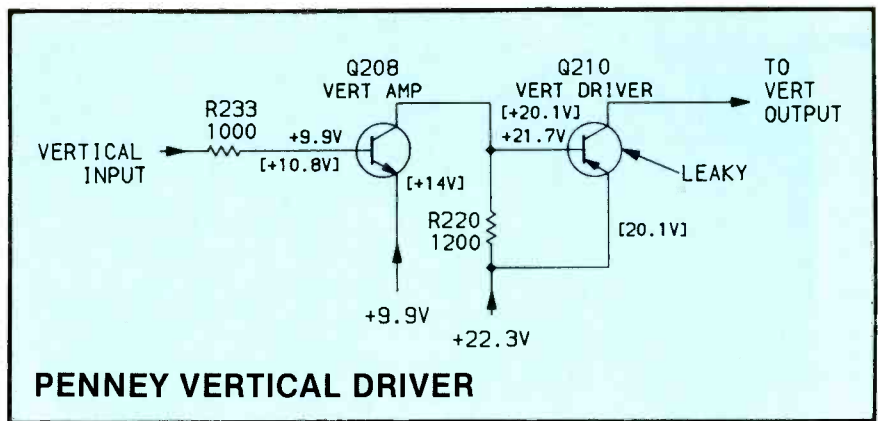
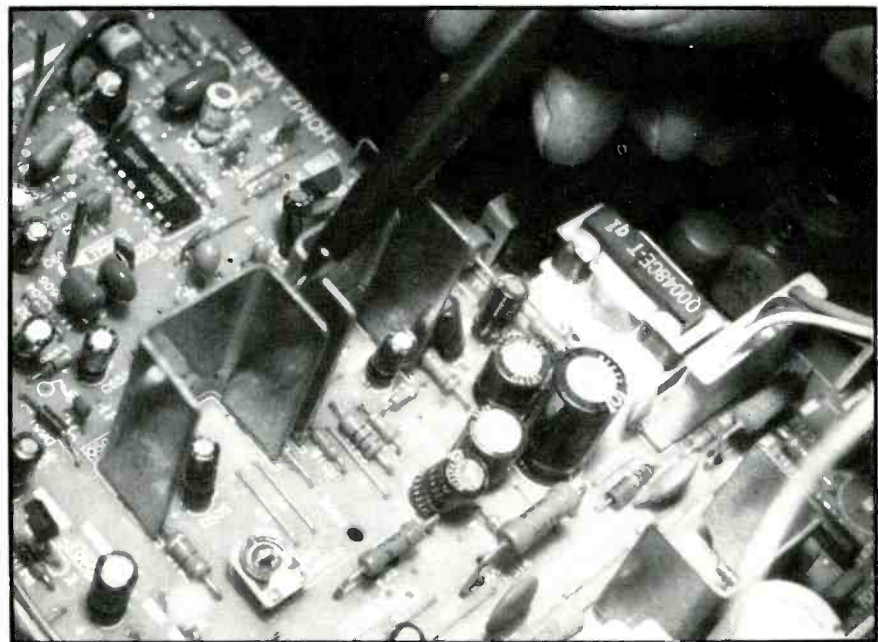

Figure 1. A good vertical-oscillator signal was scoped at Q208's base but not at its collector, or at any pin of Q210 in this JC Penney 605-1723. Leakage in Q210 had loaded down the Q208 collector and also biased Q208 for reverse bias. Replacement of Q210 solved the lack of vertical sweep (Photofact 1650-1).



Most power transistors that are mounted on large heat sinks (such as the two U-shaped ones shown here) have each collector connected electrically to its heat sink. Therefore, it is easy to check the collector voltages by touching the meter probe to one heat sink and then the other.

at base, emitter and collector of Q210. Either Q210 was shorted or leaking excessively.

Before the transistors were removed for a more accurate test out of circuit, several in-circuit junction tests were made using the DMM voltage-drop method of the diode test. Both junctions of Q208 tested normal both for voltage drop and for reverse-voltage leakage, but Q210's readings indicated virtual shorts, collector to emitter and collector to base. Evidently, the leaky Q210 was loading down the Q208 collector circuit, thus eliminating the signal there, also.

Replacing Q210 with an SK-3114 universal transistor brought back the original voltages and

signals, and (even more important) produced a picture having full height.

Loss of vertical deflection

A K-Mart model KMC-1921 also showed only a single line at the vertical center of the screen. Technicians soon learn a shortcut for those receivers that have two vertical-output transistors mounted on large heat sinks: The heat sinks usually are connected to the collector's dc voltages, allowing easier voltage measurements. As a rule, one output transistor has a comparatively high dc voltage, and the other has about zero volts.

In this case, the Q306 collector

Iwatsu's Four Independent Channel Scope.

There's 30 years of oscilloscope design and manufacturing experience behind the SS-5710-11 Series. Experience that translates to 27,000 hours MTBF. Four independent channels with no trace shift. A 3 year warranty. And that's just the beginning.

Add up our features and you'll see no other scope measures up.

The list starts with easy to read controls that make any Iwatsu scope, a pleasure to work with.

Then there's features like excellent linearity for high-frequency measurement. A special jitterless circuit, making it easier to trigger signals. Independent A and B triggers for digital applications. Plus a guaranteed time difference between channels.

More reasons for choosing Iwatsu.

- 20 kV 6" CRT with auto focus
- Maximum sweep speed of 2ns
- Separate intensity controls for A & B sweep
- Wide operating temperature range from -10°C to 50°C
- SS-5711C includes an optional counter/timer
- SS-5711D comes with DMM and counter/timer
- 60MHz Model SS-5710 is our 4-channel scope...just \$1,245 including probes, front cover and pouch
- SS-5710 is also available with optional counter/timer as well as DMM



HERE'S A FACE ANY ENGINEER COULD LOVE.

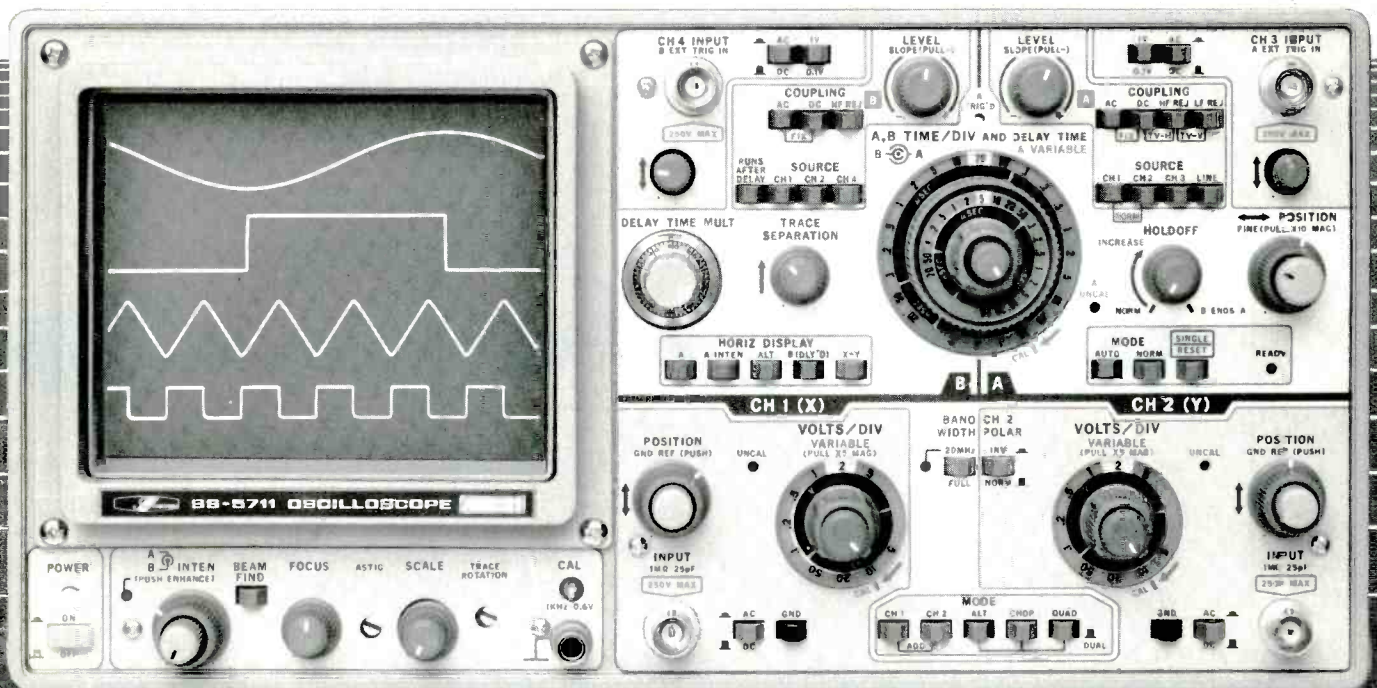

SS-5711 4-Independent Channel 100 MHz Scope including probes, pouch, and front cover. \$1,695.



IWATSU INSTRUMENTS INC.

430 COMMERCE BOULEVARD, CARLSTADT, NJ-07072 PHONE: (201) 935-5220, TWX: 711-989-0255

Circle (8) on Reply Card

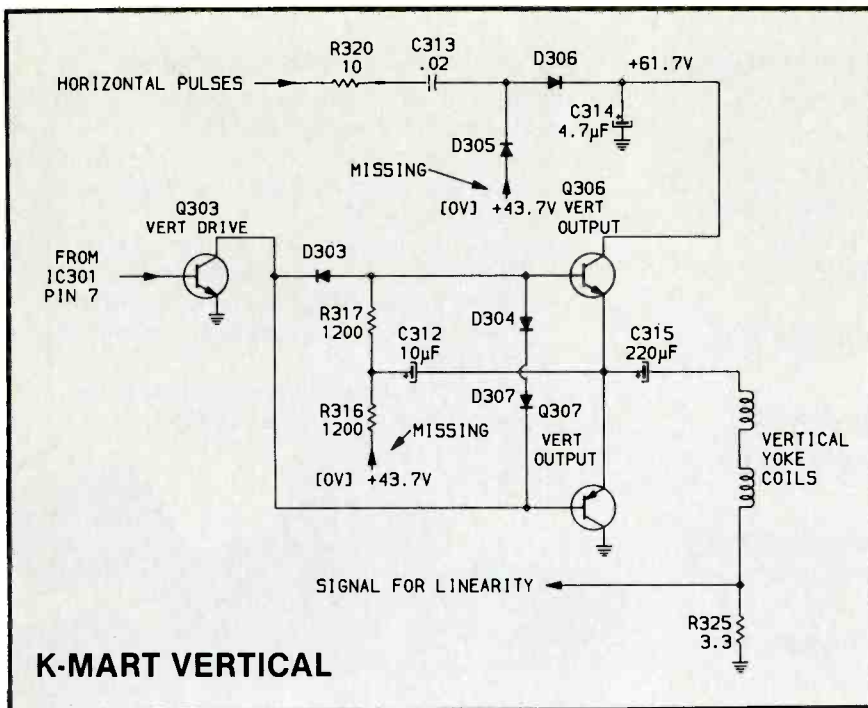

Figure 2. A much lower than normal dc voltage was measured at the heat sink of Q306 vertical-output transistor in a KMC-1921 K-Mart color receiver (Photofact 2146-1). There was no vertical deflection, just one horizontal line on the screen. After voltage and resistance tests, it was found that R318 (10Ω) was open in the power supply, which eliminated the $\frac{1}{3}$ 43.7V supply. Obviously, Q303 vertical driver transistor will not operate without collector voltage.

voltage (as shown in the Figure 2 schematic) should have been about +62V. It measured more than 40V lower than that. Even more serious, the vertical-drive transistor Q303 had almost zero collector voltage. After some extensive testing, it was found that the +43.7V source voltage was missing because R318 (10Ω) was open in the power supply.

The purpose of C313, C314, D305 and D306 has been a mystery to many technicians. However, they are an old friend in a new look; together they form a voltage-doubler circuit. Instead of 60Hz, C313 is supplied with horizontal, and D305 returns to +43.7V rather than to ground as in the older circuits. Placing the doubler on top of the +43.7V supply rather than grounding the D305 anode (as done with most doubler circuits) adds that +43.7V to any positive voltage produced by the doubler. Because +61.7V is needed for vertical-output Q306, the doubler therefore is required to supply only +18V.

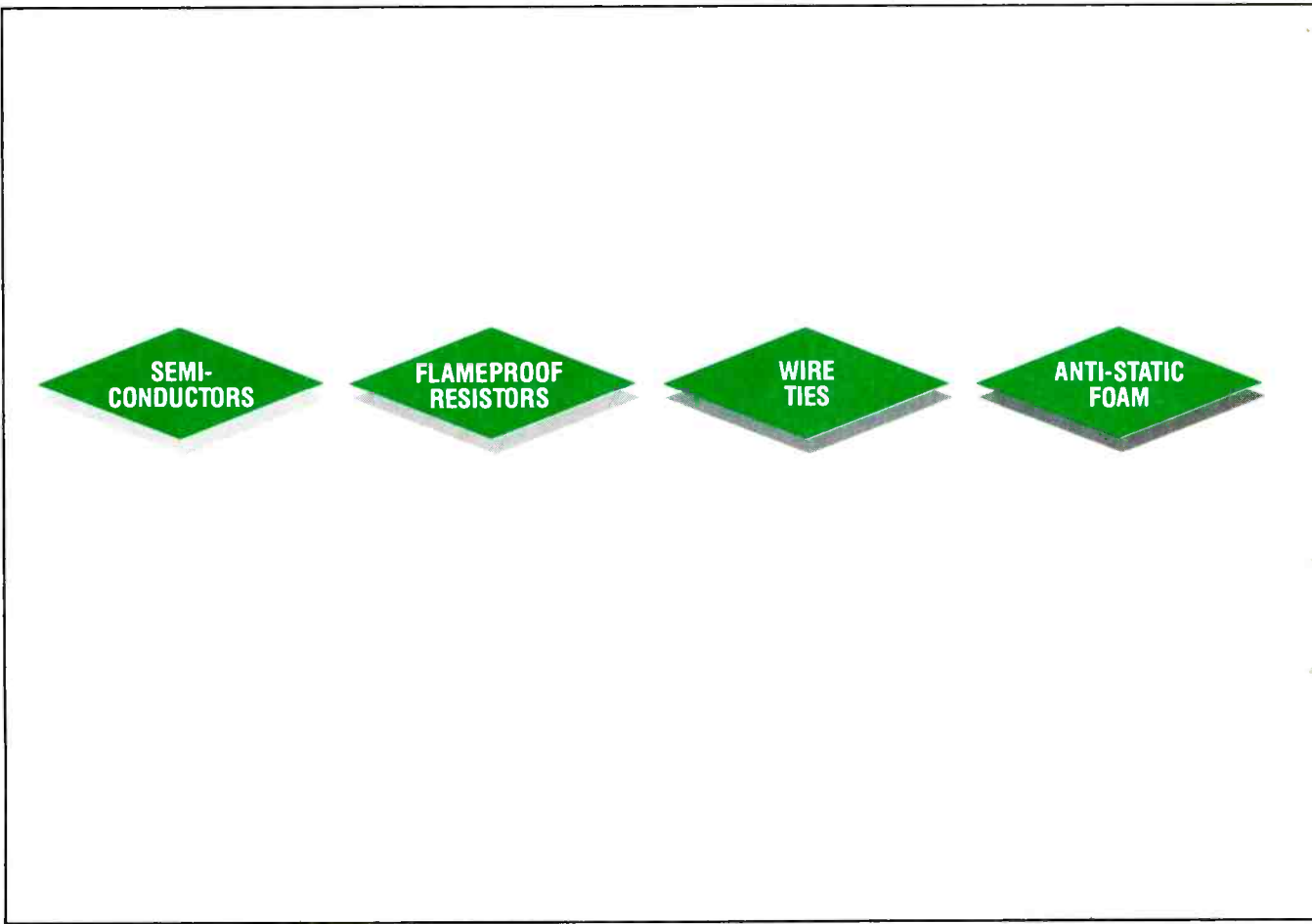

Figure 2 also shows another circuit connection that is common with many solid-state vertical systems: A low-value resistor (R325 in this chassis) is placed between the cold end of the vertical yoke and ground. The signal developed across such a resistor is nearly a pure sawtooth that is filtered slightly and brought back to the oscillator where it is compared with the oscillator sawtooth. In other words, it is negative *current* feedback that linearizes the current (not the voltage) waveform in the vertical yoke. Therefore, no variable linearity control is needed or provided on the chassis. R325 and the components connected to it have a large effect on the linearity, so they should be the first ones tested when bad linearity is the problem.

Repeating, the vertical deflection in this K-Mart KMC-1921 model was eliminated by an open resistor in the +43.7V source voltage. There was no defect in the vertical system, and the color receiver performed correctly after

R318 was replaced. However, the receiver was operated on the burn-in bench for a week (to be certain the problem would not recur) before it was returned to the customer.

No oscillator output

Terminal 7 of IC501 in a Sharp C1935 has no waveform, producing the third receiver with only a horizontal line across the screen. Perhaps a few remarks about test equipment would be helpful here. We have found a scope to be excellent for proving the presence or absence of horizontal or vertical oscillator signals. Both the waveform and the amplitude can be measured. Questions arise, however, when we try to interpret waveforms of defective output stages. There seems to be no relationship between component failure and corresponding waveform change.

Therefore, our scope was the best choice to check for the 1.5VPP vertical signal that should have been at IC501 pin 7 in this

Sharp TV (Figure 3). Unfortunately, no signal was there. That suggested three possibilities: Either the IC501 was defective, one or more of the power supplies was missing or Q501 was loading the signal excessively.

In-circuit tests of Q501 showed the transistor was not open or shorted. Dc voltages at IC501 pins 10 and 13 measured very low, although the proper +12.13V supply was connected to R502, the vertical-hold control, and other resistors that supply these two pins. This indicated a serious problem inside IC501.

A new IC501 was ordered from a Sharp parts distributor, because a universal replacement was not available. Installation of the new IC501 produced the correct waveform at pin 7 and gave normal vertical sweep on the TV screen.

Erratic height

Intermittent vertical deflection can occur from defective transistors, diodes, bad soldered joints

ONCE AGAIN, WE'RE EXTENDING OUR PRODUCT LINE.

STATIC
FIELD SERVICE
KIT

ELECTROLYTIC
CAPACITORS

Introducing the newest addition to NTE's expanding replacement line — Aluminum Electrolytic Capacitors. These NEV and NEH series subminiature capacitors are designed for demanding applications requiring high capacitance and small size, such as precision medical electronics, automobiles and the newest personal computers and disk drives. NTE's quality electrolytic capacitors operate over a broad temperature range and are available in blister pack or bulk at your local NTE distributor.

NTE

NTE ELECTRONICS, INC.

44 Farrand Street, Bloomfield, New Jersey 07003
(Outside N.J.) 1-800-631-1250 • (In N.J.) 1-800-624-2624



Circle (9) on Reply Card

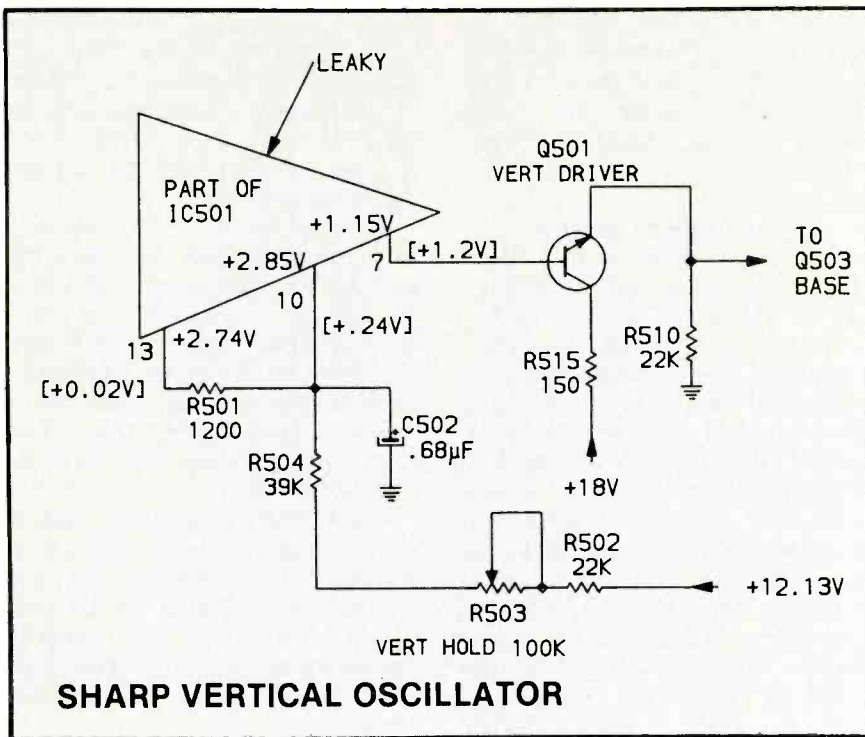

Figure 3. The voltages in brackets were measured in a model C1935 Sharp television that had no vertical deflection (Photofact 1959-2). No vertical drive signal came from IC501 pin 7 to the Q501 base. Also, the dc voltages at IC501 pins 10 and 13 were much too low, although the correct source voltage was at R502 and the voltage at the junction of R503 and R504 appeared to be correct, considering the lower voltages at the other end of R504. Also, the same +17.55V reading appeared at both base and emitter of Q501, which (in the absence of any ac drive signal) is zero forward bias. Q501 cannot conduct. Although other pins had appropriate dc voltages, the very low voltages at pins 10 and 13 of IC501 indicated a serious problem inside. Installation of a new Sharp IC501 produced normal sweep.

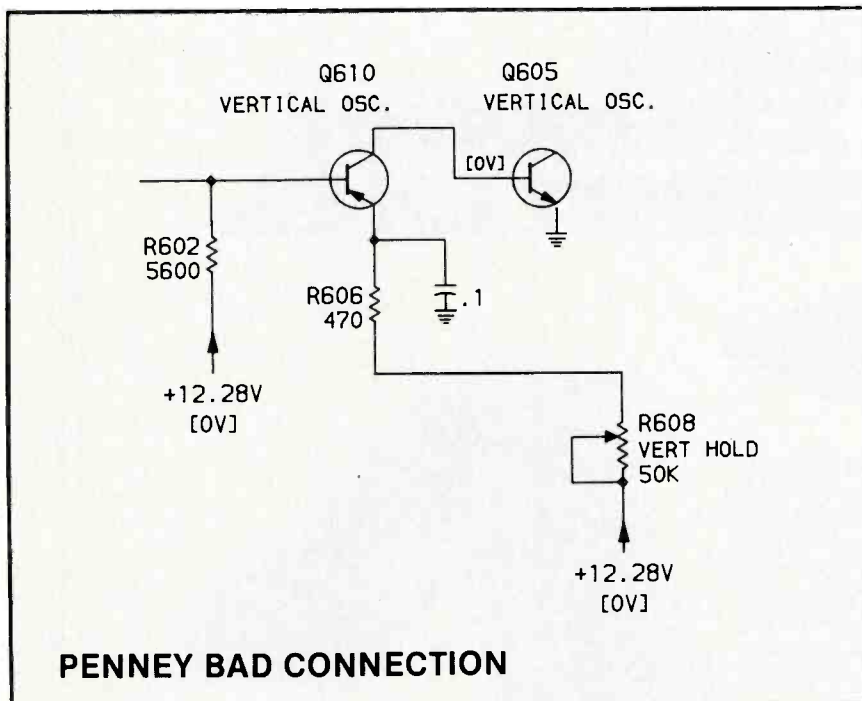

Figure 4. Certain up-and-down movements of the circuit board of one JC Penney model 685-2014 (Photofact 1766-2) would eliminate or restore vertical deflection. Dc voltage measurements revealed that the +12.28V supply was intermittent at R602 and R608, the vertical-hold control. No damage or cracks that should be reinforced or repaired were found on the circuit board, so a permanent repair was made by adding an insulated wire from Y316 in the +12.28V supply to the voltage-supply end of R608. This stopped the intermittent condition.

or a cracked circuit board. Pushing up and down on the circuit board with an insulated tool sometimes caused the height to collapse on the screen of this JC Penney model 685-2014 (Figure 4).

The dual-trace scope seemed ideal for locating the stage where the intermittent began. One probe was connected to the collector of Q610 vertical oscillator transistor with the second probe attached to the yoke signal. When the raster collapsed into one horizontal line, the waveform disappeared from both scope traces. Therefore, the problem was in the oscillator, or in the B+ supply to the oscillator.

When the scope waveforms and the vertical sweep were missing, all three pins of the Q610 oscillator transistor had zero dc voltage; no B+ supply was reaching the transistor. However, the +12.28V source voltage at the main power supply was not affected. The intermittently open circuit must be between the power supply and Q610. No cracks could be found in the circuit board that would require extensive repairs, so I solved the problem by adding an insulated wire between Y316 in the voltage source to the voltage end of the vertical-hold control. Flexing the circuit board now did not cause loss of vertical deflection.

Missing top of raster

An unusual type of insufficient height was the external symptom of this RCA CTC93E (Photofact 1810-2): The top half of the raster was missing. As shown in the photograph, two vertical-output transistors were mounted on large heat sinks.

Dc voltage measurements at Q408, the top-output transistor, were far from the schematic values. I removed Q408 and tested it, finding it was leaky. The leaky Q408 was replaced with the exact part number 142691, but the performance changed very little. Top-driver transistor Q407 was tested and the result showed it was normal (Figure 5). Other components were tested also without results until diode CR416 was reached. It had a dead short. (Replace CR416 with an exact part or a 1A/1kV standard diode.) When CR416 was replaced, the height and linearity returned to normal.

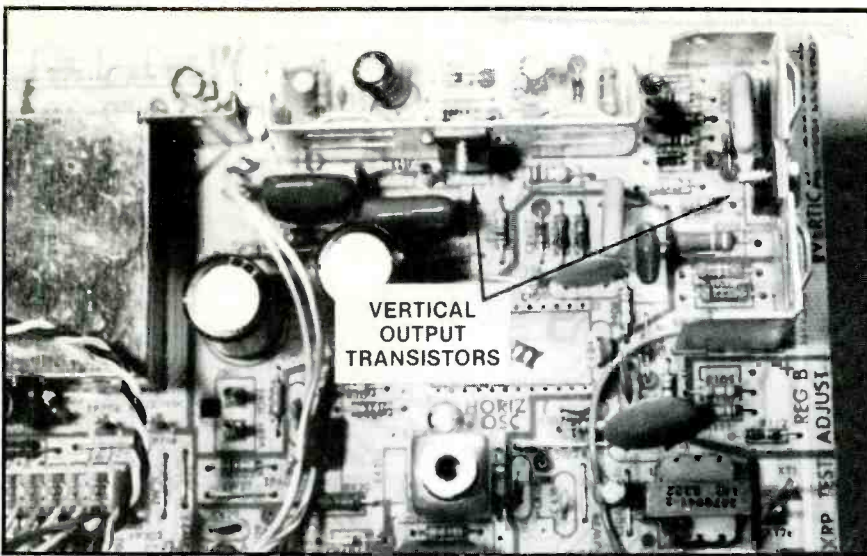

Arrows point to two heat sinks that are the mountings for the vertical-output transistors.

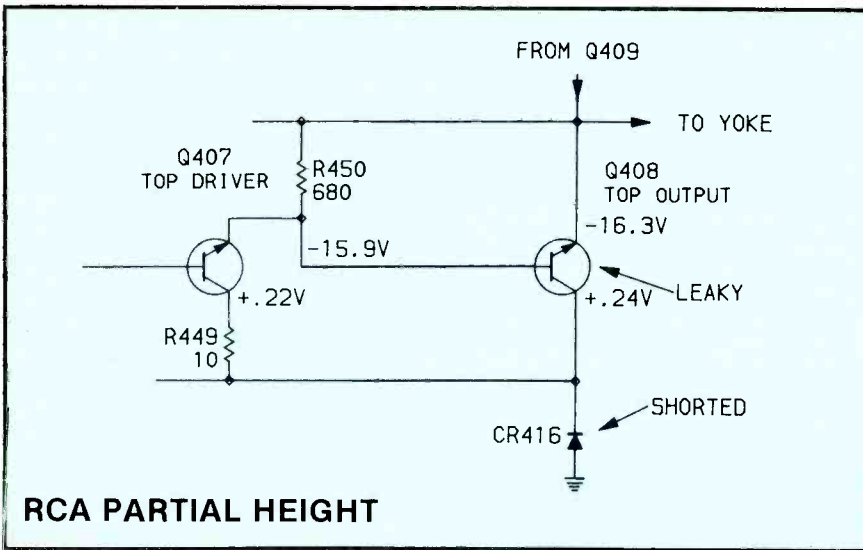

Figure 5. On the screen of an RCA CTC93E (Photofact 1810-2), there was no vertical deflection over the top half. Q408 tested leaky and was replaced. Other transistors checked normal in-circuit. But the screen was not completely scanned until a shorted CR416 diode was replaced.

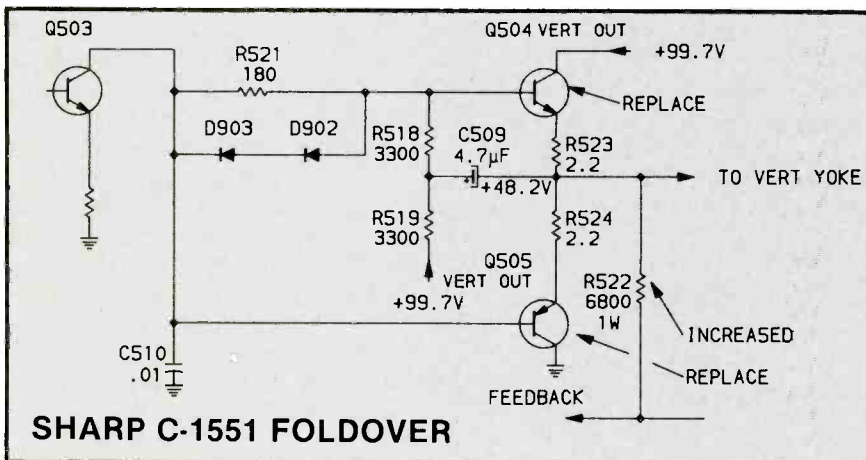

Figure 6. Foldover at the top and insufficient height at the bottom were the symptoms on the Sharp C-1551 raster. Replacement of Q504 and Q505 vertical-output transistors helped the height somewhat, but did not eliminate the top foldover. All resistors were tested. R522 had increased to almost 16k Ω . Replacement with the correct 6,800 Ω produced normal height with good linearity.

Another RCA CTC93E had a white line down through the middle with white retrace lines at the top of the raster. The dc voltage tests appeared to be within acceptable range. In-circuit tests of all vertical transistors were made with the diode voltage-drop feature of the DMM, and no problems were found.

Because retrace-switch Q403 has been known to produce retrace lines at the raster's top, I replaced it. There was no improvement.

Switch-driver transistor Q402 was the next suspect. After it was replaced with an original part number 143797, the raster and picture were normal.

Junction tests of the defective Q402 showed a normal base-to-collector reading (0.623); however the base-to-emitter reading was only 0.243 (volts of voltage drop). This indicates B/E leakage, which was causing the white line through the center of the screen with retrace lines at the top. Some of these transistor functions are so critical that approved factory transistors should be used for replacement.

Foldover at the top

A foldover line at the top and insufficient height at the bottom were the symptoms on the Sharp C-1551 screen (Photofact 1609-2). Adjustment of the vertical height control did not improve the problem. Measurements showed that the dc voltage at both vertical-output-transistor collectors was higher than usual (Figure 6). Emitter resistor R523 for Q504 and emitter resistor R524 for Q505, the two output transistors, tested exactly 2.2 Ω , as they should. Because vertical-output transistors can produce foldover, we replaced both. Q504 was replaced with an SK-3054 and Q505 was replaced by an SK-3083 (universal replacements). Although new transistors gave increased height, they didn't change top foldover.

Next, all vertical circuit resistors shown in Figure 6 were checked. R522 had increased from the original 6,800 Ω to almost 16k Ω . Replacing R522 with another of the correct specifications removed the top foldover, allowing more than enough vertical height at top and bottom with good linearity.

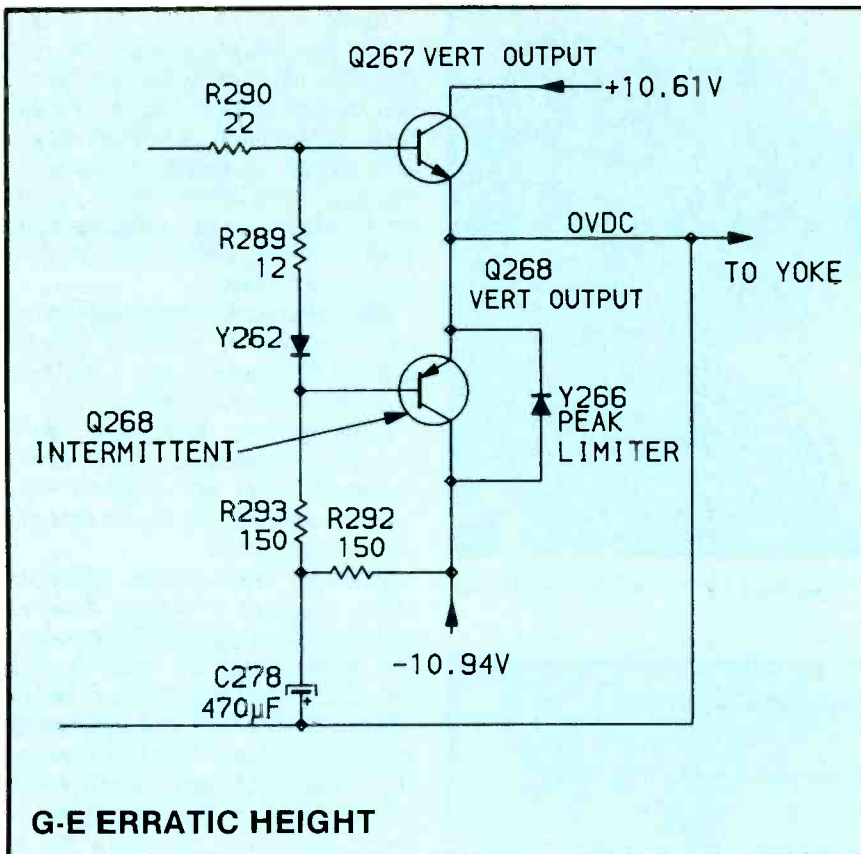
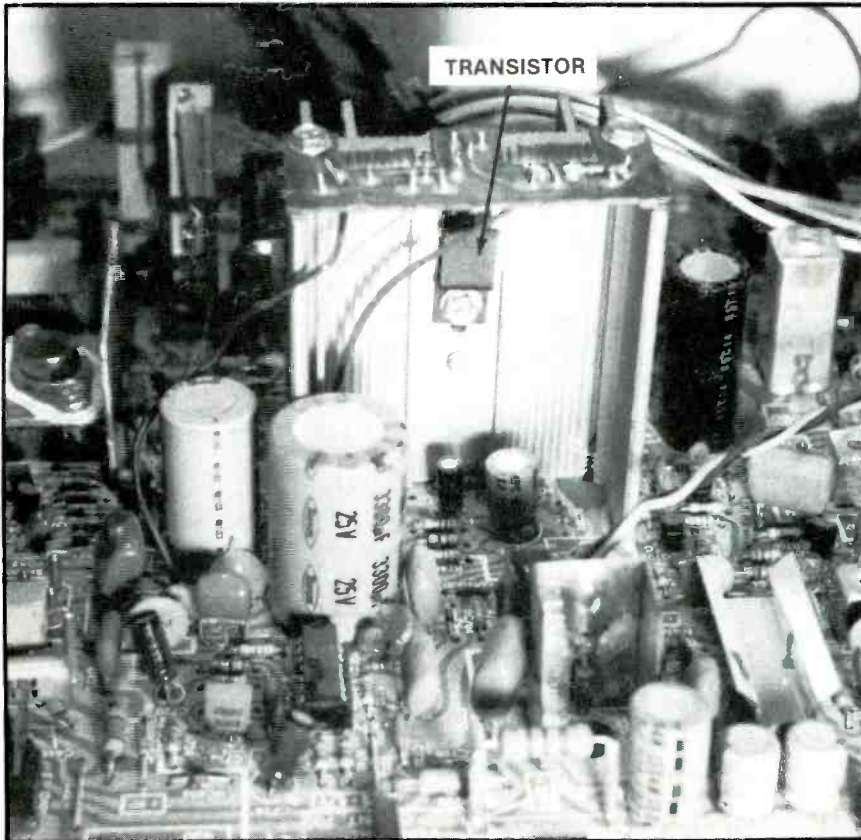

Figure 7. Collapse of the raster's top half often occurred after operation of 10 minutes or so on the General Electric 10JA color portable's screen. After several alternate applications of heat and sprayed coolant, Q268 was proved to be temperature sensitive (Photofact 1339-3). At a certain critical temperature, Q268 apparently would develop an open circuit and eliminate the top part of the picture.



Mounting of a vertical-output power transistor near the top of a heat sink allows easy access to it during hot/cold tests for intermittent transistors.

Intermittent top half

After operating for perhaps 10 minutes, the top half of the raster would collapse on the General Electric 10-inch 10JA color portable. Sometimes the missing raster half might come back, but without any predictable pattern. At other times, the receiver might operate all day without losing the picture's top.

In the Photofact 1339-3 schematic (part shown in Figure 7), Q268 provides the top half of the vertical deflection, while Q267 gives the bottom half of the sweep. For those transistors that respond to it, the alternate application of heat and cold is worth many hours of testing with sophisticated instruments. When the top half disappeared, I sprayed canned coolant on Q267 with no results, but when I sprayed Q268, the missing section was returned instantly. This was repeated several times, alternating between heating from a blower and canned coolant from a pressure can. Each time the result was the same: Q268 was intermittent when triggered by certain temperatures.

Q268 was replaced with an SK3083 and Q267 was replaced by SK3054 universal transistors. (It is advisable to replace both, even if only one is proved bad; a mismatch can cause a delayed failure of the original one not replaced.) A long heat run plus hot/cold testing proved the *intermittent vertical deflection had been repaired properly*.

A 2-inch picture

The picture on a Philco C2914KW (Photofact 1826-1) would collapse to a height of about two inches after about one minute of operation after power-on. According to the schematic, the vertical oscillator and driver are in IC302, and they supply drive direct to Q300 bottom-output and Q302 top-output transistors (Figure 8).

Coolant sprayed on these power transistors and on IC302 did not change the insufficient height. But this type of flat vertical output transistor has a history of erratic failures, so both were replaced, Q300 with an ECG752 and Q302 with an ECG153 universal type. Following replacement of the two transistors, *the intermittent 2-inch*

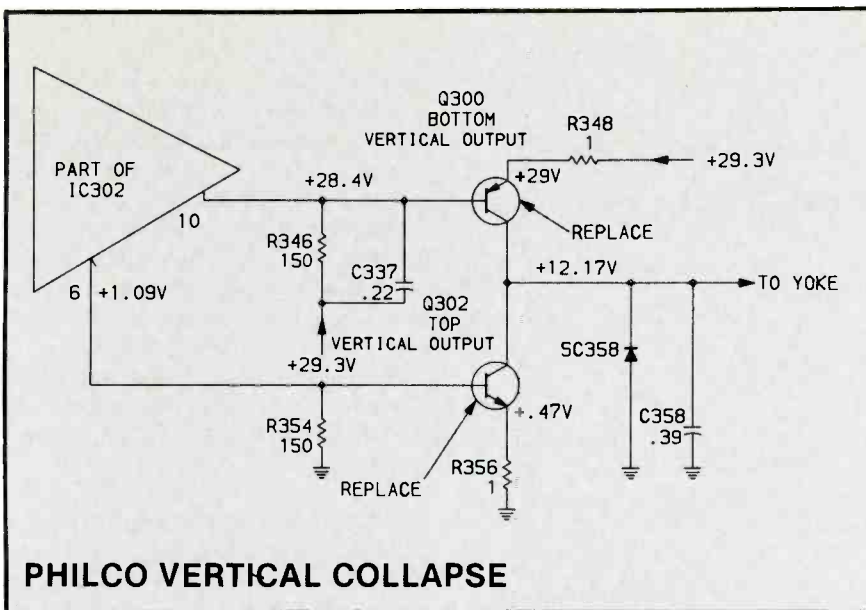

PHILCO VERTICAL COLLAPSE

Figure 8. After about a minute of operation, the picture on a Philco C2914KW (Photofact 1826-1) would collapse to about two inches. Coolant was sprayed on IC302, Q300 and Q302, but without results. Finally, Q300 and Q302 were replaced with the proper universal types and the intermittent collapse was eliminated.

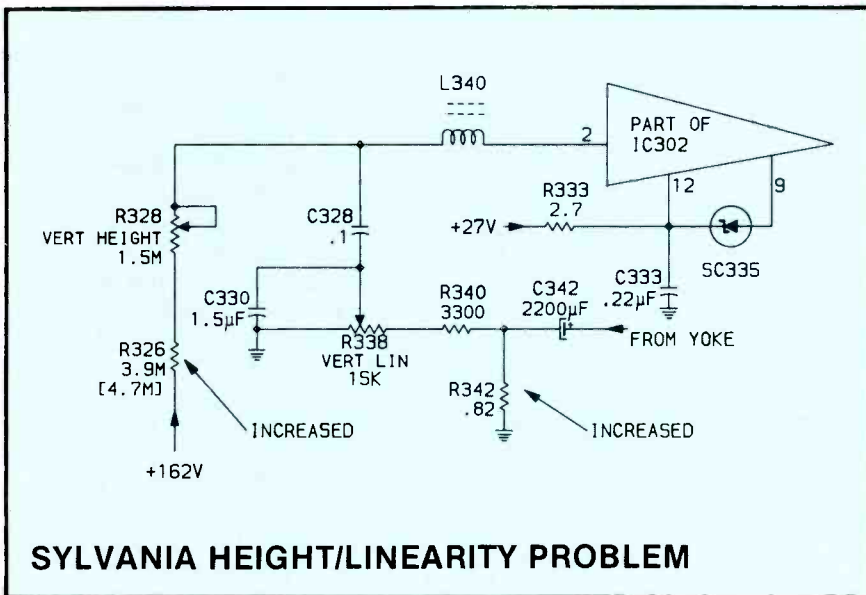

SYLVANIA HEIGHT/LINEARITY PROBLEM

Figure 9. In one E20-chassis Sylvania (Photofact 1595-1), there were no vertical driver signals from IC302 pins 6 and 10 so it was replaced with a ECG794. This gave height, but with poor linearity at the top. After tests, resistors R342 (0.82Ω) and R326 (3.9MΩ) were replaced with correct values, giving good linearity.

height was eliminated, and performance was satisfactory.

Heavy horizontal lines

At the beginning, the Sylvania E20-2 chassis (Photofact 1595-1) had no vertical deflection, showing only one familiar horizontal line. After vertical driver IC302 was replaced, several firing lines appeared in the center of an otherwise normal raster. The vertical-output transistors were replaced, but the raster was unchanged.

In some vertical circuits, only original part-number transistors operate correctly, so Sylvania output transistors were ordered and installed. The lines remained in the raster. In combined inspiration and desperation, we replaced IC302 again with another universal ECG794. The flashing lines were gone. The first universal IC replacement had been defective.

With another E20 Sylvania, IC302 was replaced because there were no drive signals for the

vertical-output transistors at pins 6 and 10. Installation of ECG794 produced vertical sweep, but the picture was pulled down from the top, giving poor linearity. DC voltages of IC302 measured within the usual tolerances (Figure 9). Resistor R342 (0.82Ω in the yoke return to ground) had increased to 1.5Ω, and 3.9MΩ R326 had increased to almost 6MΩ. (Note: in some versions, R326 originally was 4.7MΩ.)

After R342 and R326 were replaced with new resistors of the correct values, the insufficient height and poor linearity were corrected.

An unusual problem

A typical horizontal white line was the symptom on the screen of this Magnavox T985-9 chassis, indicating a total loss of vertical deflection. First, the vertical module was removed for tests of the individual components, because the module is not readily available when plugged in and powered. According to resistance and diode/junction tests, all components appeared to be normal.

The module was reinstalled, and some voltage measurements were made, although these can be difficult because the module is wedged between other components. At the collector (case) of Q102 the collector measured +0.6V when it should have been -14V, and the Q101 collector measured almost +30V instead of the usual +14.5V.

Because the output transistors cause most of the vertical-deflection problems, we replaced both of them and plugged in the module. The height was not improved. To avoid excess labor time, the television was set aside until a replacement vertical module could be obtained two days later. Unfortunately, the new module did not restore the deflection either. Ohmmeter measurements of the vertical yoke circuit showed proper continuity. With a new module, new transistors and no yoke problems, nothing remained to be suspected. Or did it?

Q101 and Q102 continued to have the same incorrect collector voltages. Notice in Figure 10 that D4 and C17 (on the module) are supposed to supply about -14V to

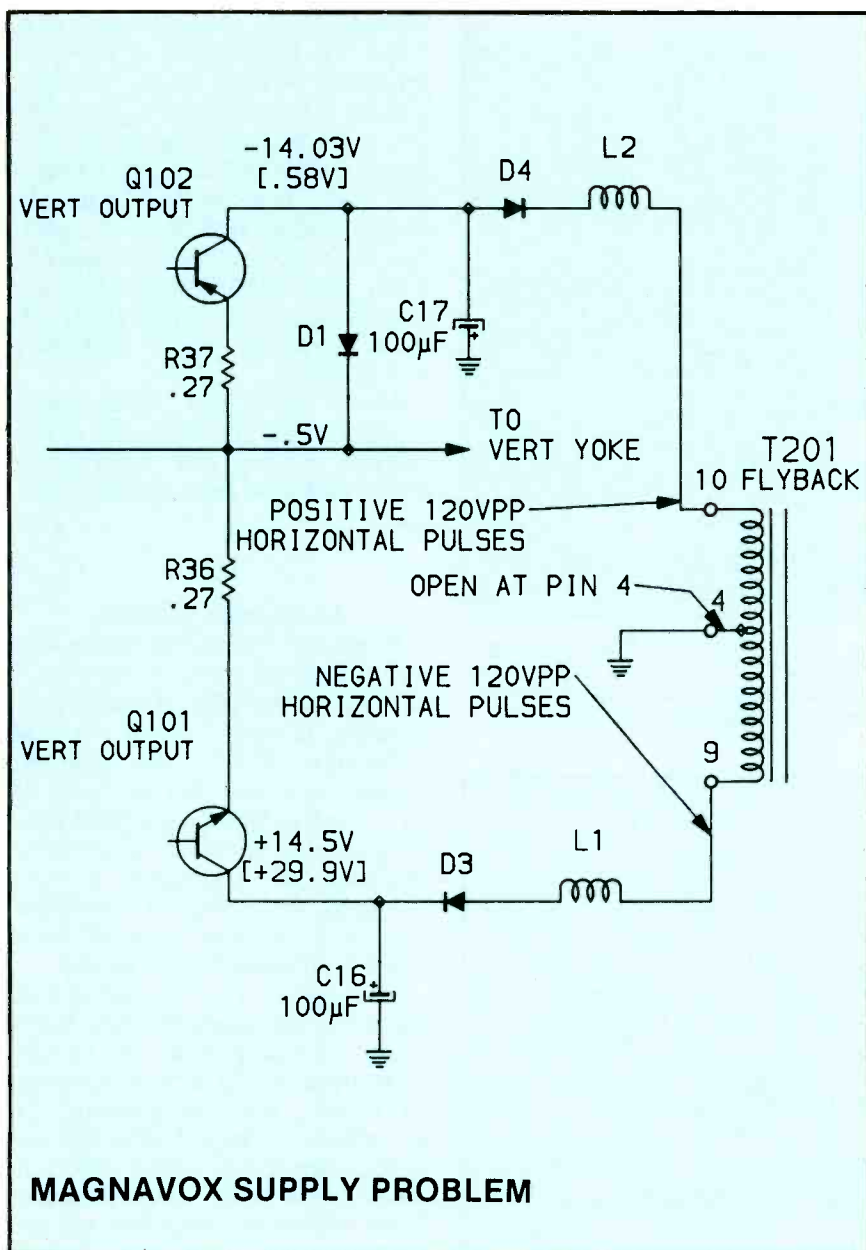

Figure 10. A Magnavox T985-9 had no vertical deflection. It had no height after the vertical-sweep module and both vertical-output transistors (Q101 and Q102) had been replaced. Each output transistor has its own power supply, one positive and the other negative (Photofact 1696-1). This article tells why one had twice the rated voltage and the other had almost none. Also, the easy solution is given.

the Q102 collector, while D3 and C16 should supply about +14V to the Q101 collector. Perhaps the measured lack of negative voltage at the Q102 collector was caused by a loss of horizontal power that should be supplying D4. But the resistance from T201 flyback pin 10 to pin 9 was normal, and neither pin had any continuity to ground, although the schematic called for the pin-4 centertap to be grounded. Pin 4 was not grounded, so the cure was easy: A ground wire was added between flyback pin 4 and a board ground, allowing

the vertical circuit to operate perfectly, with both positive and negative supplies having correct voltages.

Even after the defect is known and corrected, one large question remains unanswered. With both rectifier circuits floating without a ground (Figure 10), why did one have double voltage apparently rectified from both windings, while the other rectifier put out virtually zero? Perhaps the answer is that whichever rectifier/filter/load has the greatest load pulls down the horizontal signal on that side

so it becomes the rough equivalent of a ground. With one supply grounded, the other supply operates from the sum of the two windings in series. In this case, the D4/C17 circuit and its load was lower than the other. Without a centertap, very little difference between the two supply loads can shift the apparent ground a large amount, partially because the current is almost zero at this time.

We could have saved much time if we had known at the beginning where to add that little ground wire!

Comments and summary

An excellent first test for complete loss of vertical deflection is to scope the output of the vertical oscillator (or its equivalent) and the output of the vertical sweep (which is the signal sent to the yoke). If the oscillator has no output, it is useless to test the remainder of the vertical circuit. But if the oscillator has proper output, and the yoke signal is missing, the problem is between those two points, or it might be in the dc-voltage supplies for those stages.

Intermittent transistors and ICs often can be triggered *on* or *off* (and thus identified as the problem) by alternate applications of heat and canned coolant. Flat or TO-220 type transistors have a tendency to break down under load, causing intermittent operation. When there are two together and one becomes defective, replace both. Doublecheck all transistor or IC replacements; some new components might be defective or intermittent. Although most universal transistors operate satisfactorily in vertical-output stages, obtain original parts for vertical switching and retrace stages.

Always apply silicon grease between power transistors and their heat sinks. This helps move the transistor heat to the heat sink and thus prevent excessive transistor failures. After a module has been replaced, and the problem remains, begin testing all external circuits that connect to the module in any way. Many vertical problems originate in a faulty power-supply voltage. Therefore, the supply voltages should be among the first items to be tested.

ES&T

Test your electronic knowledge

By Sam Wilson

1. Modern color receivers use sophisticated shutdown circuits that monitor either the flyback-pulse amplitude or

- A.) the line current.
- B.) the ratio of the line current to the line voltage.
- C.) the amplitude of the flyback pulses vs. the picture tube current.
- D.) the rise time of the flyback pulses.
- E.) Choices A and B are both correct.

2. To remove a surface-mount resistor, unsolder the leads and

- A.) pry it off the board.
- B.) lift straight up.
- C.) push down on the component, then lift straight up.
- D.) twist it off the board.
- E.) turn the board upside down and let the resistor fall off by its own weight.

3. A surface-mount resistor is marked with the number 223. This means that

- A.) it is shown as R223 on the schematic.
- B.) it is a precision 223Ω resistor.
- C.) it is rated at 22Ω, 3W.
- D.) it is a 22k resistor.
- E.) None of these choices is correct.

4. In understanding how a single-tube camera can reproduce the three primary colors of red, green and blue from the stripe filter, it is necessary to divide the color video camera into the three major sections that are responsible for its operation. They are: the deflection system, the video processing circuits and

- A.) matrixing.
- B.) mixing.
- C.) gating.
- D.) amplifying.
- E.) synchronizing.

5. In the GHM liquid crystal display, there is _____ dissolved in a positive liquid crystal matrix.

- A.) an ion dispersant
- B.) a dye
- C.) an alkali solution
- D.) India ink
- E.) a blue penetrant

6. If you replaced the horizontal-output transistor, and it is instantly destroyed when power is applied,

- A.) determine at which point the sweep signal has been lost.
- B.) replace the flyback transformer.
- C.) troubleshoot the low voltage supply.
- D.) use an ohmmeter to check the picture tube.
- E.) None of these choices is correct.

7. The same square wave is being used to test two different amplifiers. Assume the same scope setup for both tests. The leading edges of the output waveforms are shown in Figure 1. Which of the following is correct?

- A.) The amplifier for (a) has the greater bandwidth.
- B.) The amplifier for (b) has the greater bandwidth.
- C.) You cannot determine the bandwidth from this test.

8. Which of the following statements is correct regarding cleaning the video heads in a VCR?

- A.) Use a lint-free material or Q-tip dampened with a freon compound.
- B.) Do not use a lint-free cloth or Q-tips for this job.

9. In a certain receiver the oscillator signal that is delivered to the mixer is exactly equal in frequency to the carrier. The filtered output of the mixer, then, is the audio signal. This type of receiver is

- A.) reflex.
- B.) regenerative.
- C.) super-regenerative.
- D.) homodyne.
- E.) superheterodyne.

10. A study based on a nationally representative sample of 17,000 households shows that

- A.) one-half of all color television receivers purchased 25 years ago are still in use.
- B.) four out of five sets are still in use ten years after purchase.
- C.) one-fourth of the color TV sets over five years old are still in use.
- D.) there are virtually no TV sets still using tubes.
- E.) portable models represent only 5% of the total color TV sets sold in the United States.

Answers are on page 60

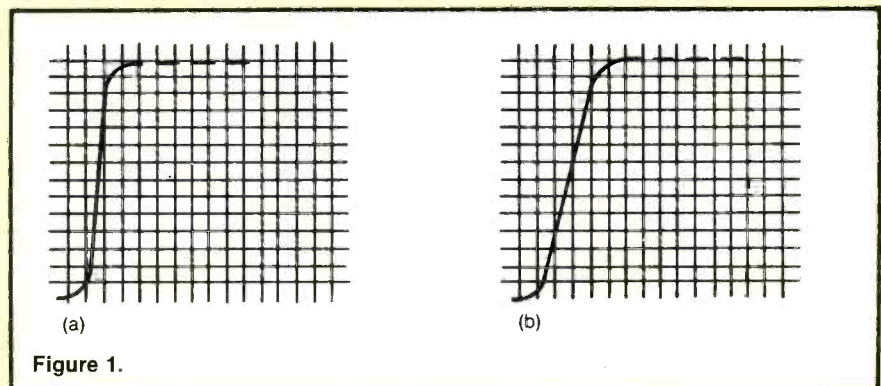

Field-strength meter or signal-level meter?

By James E. Kluge

Ask MATV or CATV technicians if they have used a field-strength meter and they might look at you in amazement and say, "Sure, haven't you? How could you install, balance-up or troubleshoot a system without one? That's one tool I couldn't get along without."

By this time you realize they may not know what a field-strength meter is. Unless any are radio hams or have worked for a broadcaster, their idea of a field-strength meter is an instrument to which you connect a coaxial cable in order to measure signal voltage levels on the coaxial lines comprising an MATV or CATV system.

In the early days of MATV/CATV, the instrument that was used to measure signal levels was referred to as a *field-strength meter*. This term undoubtedly was popular because it was 1.) tuneable over the frequency range of interest and 2.) indicated a relative field intensity as seen by a remote antenna located at the headend of the system. The antenna, in the case of an MATV system, was on the roof; in the case of the CATV system, probably it was on a high tower or on a hilltop close to the headend. The indication of relative field intensity was *strictly relative*: between the antenna and the meter were many devices both passive and active. Most likely the antenna gain was known only as an approximation. In addition, there was considerable loss attributed to coaxial cable, splitters, band separators, baluns and such as well as gain from pre-amps, distribution amps, line-extender amps and bridger amps, to

name a few. And, in many cases, the signal source may not be an antenna—it may be a VCR or CCTV system.

Field-intensity meter

A true field-strength meter has a calibrated, tuned dipole antenna connected to it. The instrument reads out the voltage developed across the antenna terminals connected across a 50Ω input impedance. Knowing various parameters of the field being measured, the electric field intensity can be determined and expressed in units of microvolts per meter as seen by the dipoles placed in the electromagnetic field.

Signal-level meter (SLM)

Conversely, the levels most MATV/CATV technicians are reading are simply volts measured across a 75Ω impedance. The meter scale usually is calibrated both in volts and dB relative to 1 millivolt (dBmV) and has a range

This field-intensity meter includes a calibrated half-wave dipole antenna to measure electric-field intensity of a radiated electromagnetic field. Frequency range covered is 45MHz to 225MHz. A continuously tuneable dial on front panel and telescoping dipole elements (each adjustable to $\frac{1}{4}$ wavelength) permit tuning to the frequency being measured. Charts and data accompanying the instrument allow conversion of a dB-meter reading to field intensity in units of volts/meter. The FIM-71 also may be used as a SLM by connecting signal cable to BNC-type 50Ω input connector. Voltage measurements can be made over a range from $10\mu\text{V}$ to 10V rms.

of $10\mu\text{V}$ to 2V. That's why it's called a *signal-level voltmeter*. It is designed to measure signal voltage, not electric fields. It simply is a specialized, tuneable RF voltmeter designed both for MATV/CATV work and to cover a frequency range from 54MHz to 216MHz (VHF channels 2 to 13) and 470MHz to 806MHz (UHF channels 14 to 69).

Other signal-level meters designed for CATV work cover the CATV bands that include the VHF midband (120MHz to 174MHz) and VHF superband (216MHz to 300MHz) frequencies. Where required, a converter is available to cover the sub-channel frequencies from 18MHz to 48MHz.

A typical signal-level meter comes in a portable carrying case and is powered by a 9V transistor-radio battery. Its input is a common F-jack connector on the front panel. Readout is via a meter switchable over several scales to cover a range from $10\mu\text{V}$ to 2V via several front-panel slide switches that attenuate the incoming signals by either 20dB or 6dB.

A front-panel switch allows you to go from VHF to UHF (or superband). A built-in loudspeaker or earphone jack permits you to listen for carriers as you are tuning the VHF or UHF bands.

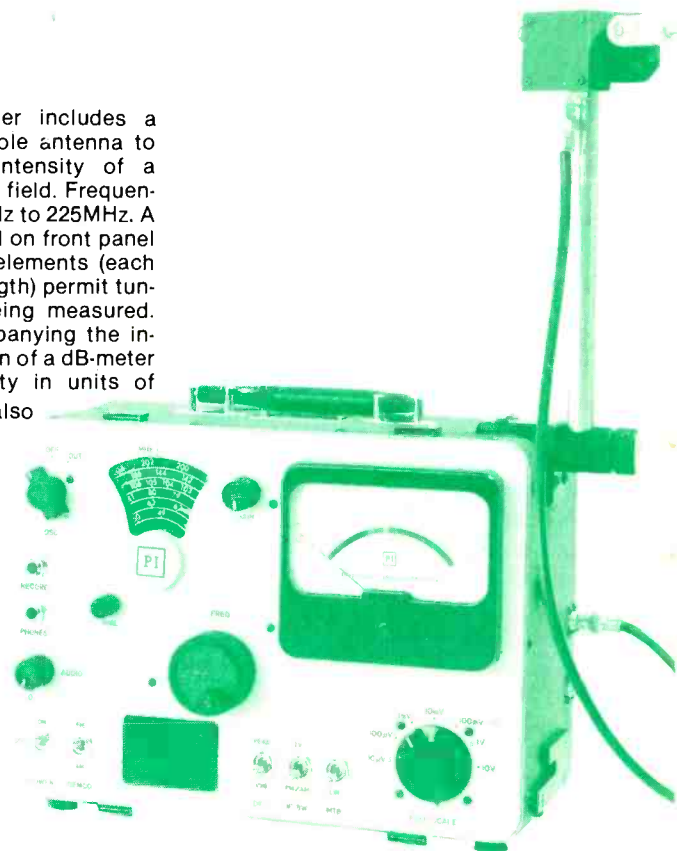

James Kluge is technical editor, Research and Development Division, Winegard Company, Evergreen, CO.

Applications

A signal-level meter has many uses in MATV/CATV work. Most common of these are measuring relative signal levels at various locations in an MATV/CATV system and orienting an antenna for maximizing received signals. (The meter indicates signal-voltage level on the line and responds to a change in the orientation of the antenna position rather than a change in field intensity.)

Antenna measurements

When orienting an antenna, connect the signal-level meter to the download through a suitable matching transformer if necessary. The SLM has a 75Ω input impedance; if the download is 300Ω balanced, you'll need a balun transformer. Then tune the SLM to the weakest picture carrier and orient the antenna for maximum signal.

While still connected to the antenna, tune the SLM to each picture carrier and record the levels. Having a record of carrier levels will help you design or troubleshoot the MATV system later.

Channel balancing

If the carrier levels vary by more than a few decibels, it would be advisable to balance them, using a channel separator and single-channel amplifiers with variable

gain controls. By monitoring the outputs with a SLM, the gains can be adjusted to balance all channels relative to each other.

AGC adjustments

If in the process of monitoring the levels, it is observed that instead of the levels being constant, they fluctuate or vary with time, it may be advisable to employ amplifiers having automatic-gain control (AGC). In order to make them work properly, they have to be set up so that the point at which they operate is centered between the upper and lower levels of AGC effectiveness. The SLM can be used to measure these levels and center the operating level between them. One way this is done is to monitor the signal at the amplifier output while varying the input signal with a calibrated attenuator. Add attenuation until the output drops ½dB. Then remove attenuation until the output increases ½dB. The total attenuation spread will tell you the AGC range. From this you can adjust the average input level to fall halfway between the two limits. Procedures for making AGC adjustments vary with manufacturers but the SLM can be used to monitor the input and/or output levels while making the adjustments.

Tap isolation adjustments

A SLM also can be used to set tap isolation on selectable or variable isolation taps by monitoring the input and tap levels as adjustments are made. Increasing the isolation of selectable taps requires the technician to snip out one or two of three parallel resistors.

Insertion loss

In the same manner, the SLM can be used to measure insertion loss, by noting the difference between input and output levels. Likewise, the gain of an amplifier can be determined by subtracting the output level in dBmV from the input level in dBmV.

Amplifier overload

SLMs also help determine the overload level at the input of a broadband amplifier. By reading the individual channel levels in volts, they can be added together to determine the total voltage level applied to the input of a distribution amplifier and thus avoid overload and consequent cross-modulation effects.

EMI

By tuning the SLM over the band of interest, interfering signals can be located, and their frequency and voltage level determined, by noting signals where a signal should not be. By diagnosing the picture or listening to the built-in speaker or plug-in earphone, the nature of the signal may be determined in order to target its source. You then can select a trap, an antenna array or antenna orientation to minimize or effectively eliminate the interference. If using a tuneable trap to knock down the interfering signal, the interference can be monitored with the SLM while tuning the trap for maximum attenuation.

Monitoring modulation

Most SLMs have a jack to which either an oscilloscope or an earphone can be connected to permit listening to or watching the modulation of the video carrier to which the SLM is tuned. You also may tune the SLM to the slope of the sound carrier and listen to slope-detected FM sound.

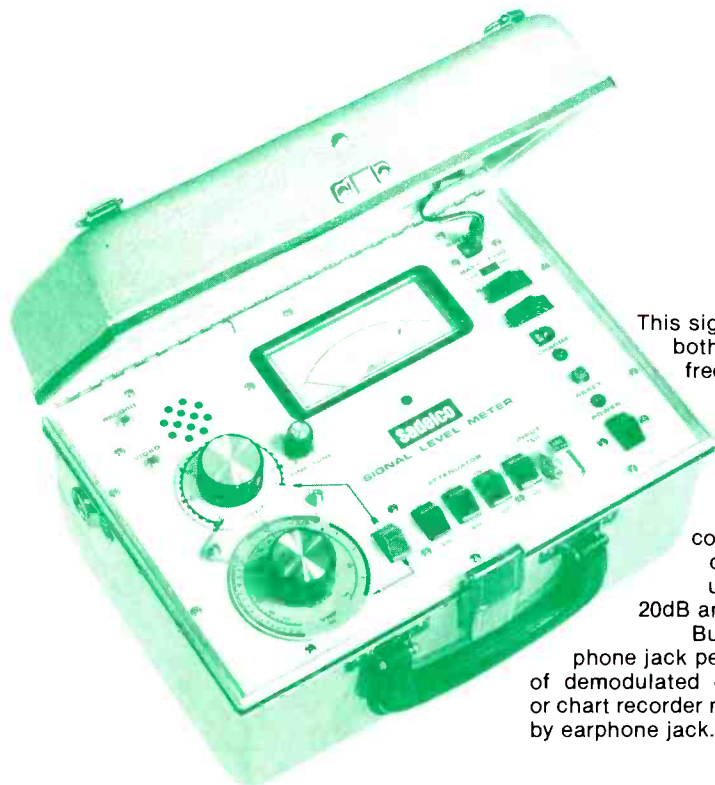

This signal-level meter covers both VHF and UHF TV/FM frequency bands. Continuously tunable over two bands, the FS-3DUV accepts input signals ranging from 10μV to 2V via coaxial cable connected to 75Ω type-F connector. Input-attenuator consists of three 20dB and one 10dB switches.

Built-in speaker and earphone jack permit audio monitoring of demodulated carriers. Oscilloscope or chart recorder may also be connected by earphone jack.

ES&T

Test components and ICs with your scope

By Al Kovalsky

Testing the signature of a component or circuit suspected to be bad against that of a known-good one provides quick isolation of problem areas, such as shorts, leaks, opens and bonding problems. Any significant difference in the two signatures indicates failure in the device being tested. A switcher allows you to selectively switch the pins of an IC into the circuit to test individual circuit segments.

The usefulness of any dual-trace oscilloscope can be extended with an inexpensive add-on test module that helps you analyze and compare the trace characteristics of suspected-bad and known-good components. Differences in trace patterns indicate failures.

This type of comparison testing is relatively easy to do and can be performed almost equally well in the field or in the lab. Comparisons of trace characteristics, viewed on the scope, can be used for general-purpose troubleshooting. This setup will test all types of analog, digital, and hybrid components—including resistors, capacitors, diodes, transistors, and ICs (up to 40 pins). The technique works equally well with fully assembled boards, permitting in-circuit, power-off, non-destructive testing.

Comparison testing with a scope

Your scope already may have a component test feature, as indicated by output jacks on the front panel (Figure 1). The jacks correspond to power and ground for a small test voltage, typically less than 9Vac. This voltage may be applied with test clips across component input leads. The output of the component is displayed by the scope as the voltage/current relationship, or the component's *signature*.

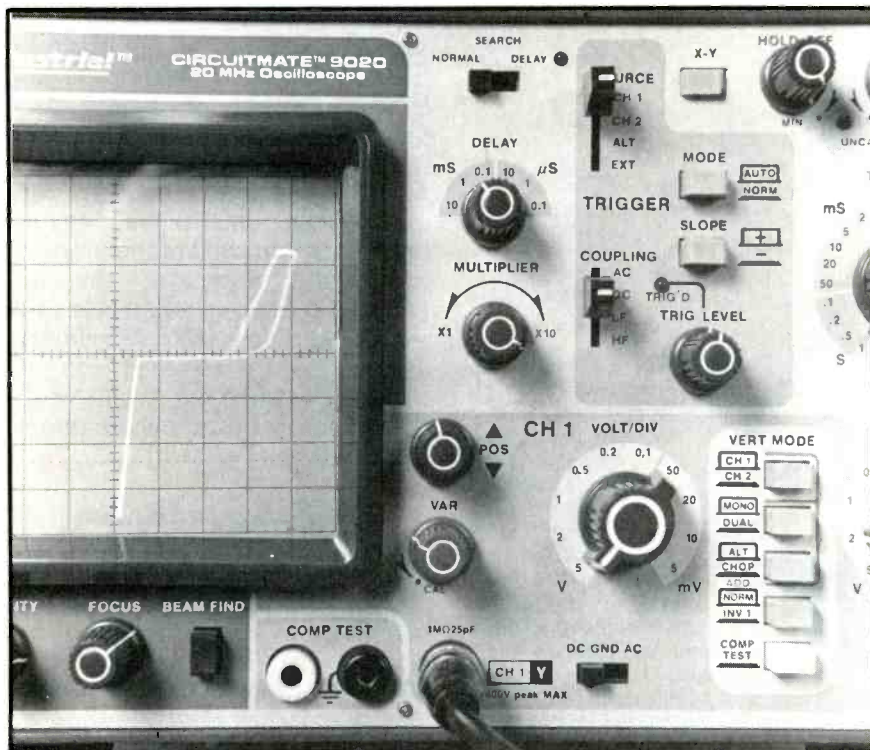

Figure 1. Some scopes have a component-test feature that provides a low-current RMS output to be applied to unpowered devices.

Kovalsky is with Beckman Industrial, Brea, CA.

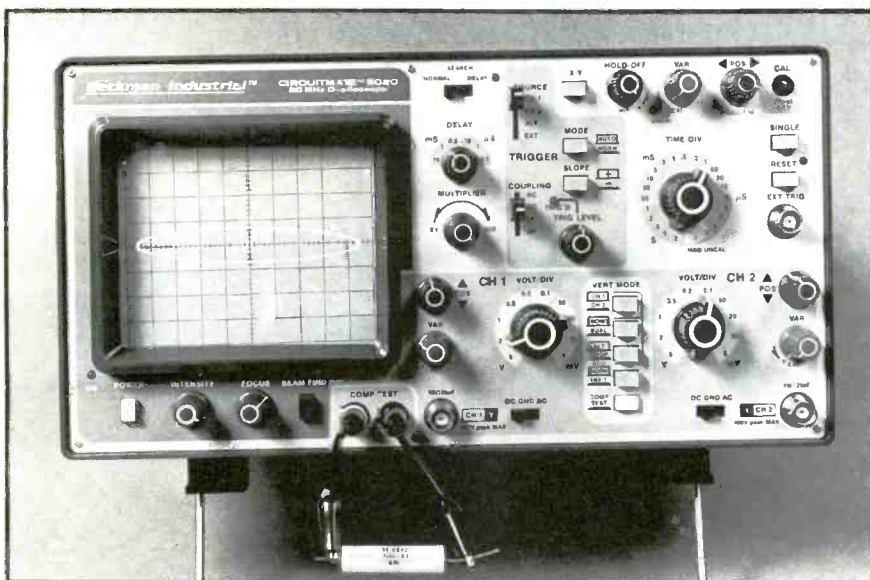
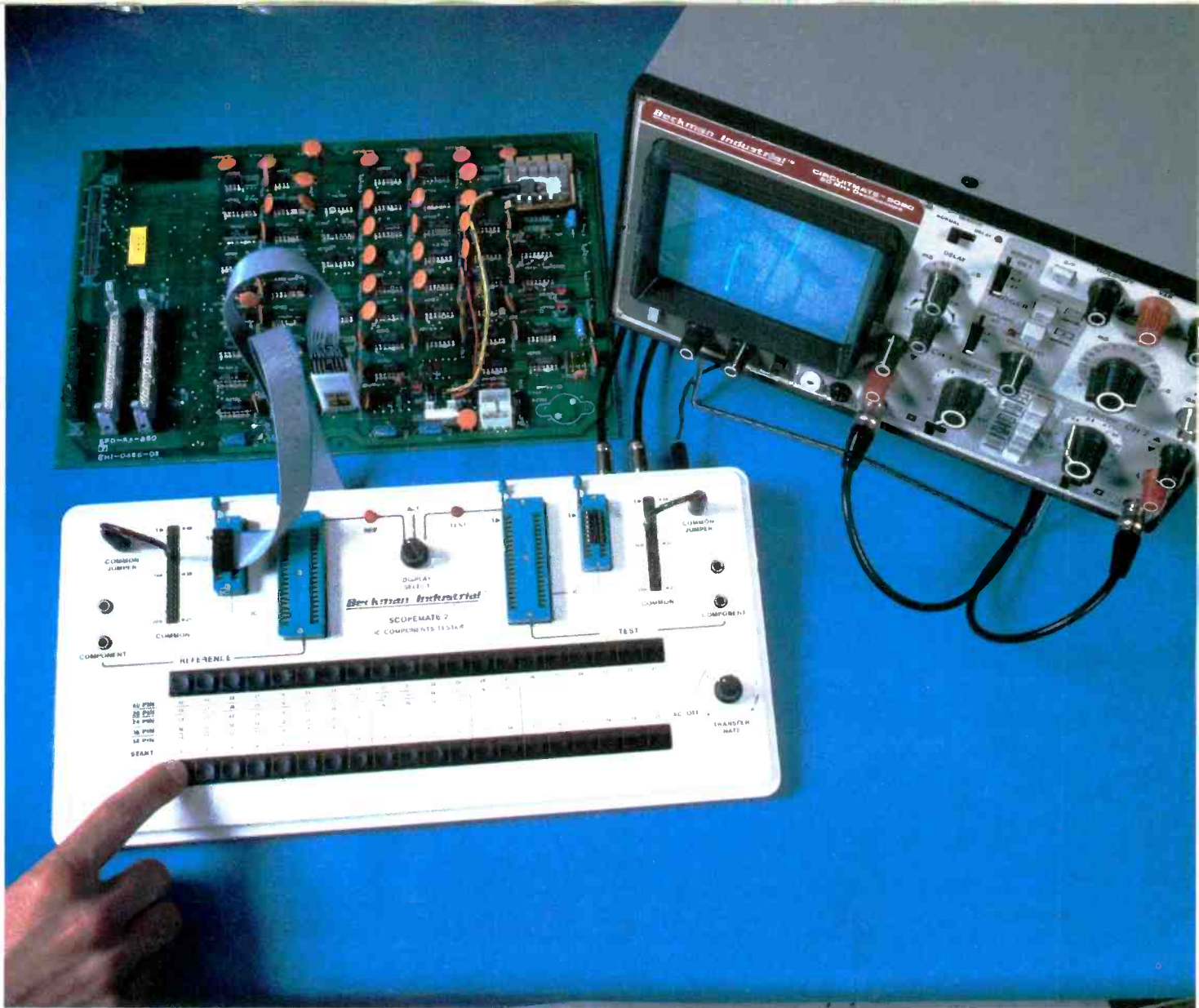

Figure 2. The component-test feature on a scope is being used here to test a capacitor. Without an add-on component test module for the scope, testing of ICs must proceed pin by pin.

Without an add-on test module, component testing on a dual-trace scope requires a component test feature not included in all scopes like the one shown in Figure 2. Testing must proceed one component at a time. On an IC, outputs must be tested pin by pin.

The process of comparison testing is to test a known-good component, or *reference device*, against a suspected-bad component, or device under test. Any difference in component signatures indicates a malfunction in the device being tested. With the component-test feature described above, comparing devices would involve connecting, testing and disconnecting first one, then the other.

A drawback of this approach is that ICs and boards must be tested

Switchers permit you to switch the pins of an IC socket into the test circuit selectively to test individual segments *within* the IC.

pin by pin and contact by contact. The main purpose of a test module, such as Beckman's Scopemate 2, is to eliminate such tedious, step-by-step procedures by permitting simultaneous comparison testing of entire components or subassemblies. For example, testing can proceed IC by IC, either individually or onboard. The test module also provides the test voltage, which is a mandatory feature if your scope doesn't have a component-test output.

These test modules are often called *switchers* because they permit you to switch the pins of an IC socket into the test circuit selectively. As shown in Figure 3, the module itself is actually two test rigs in one: It has two sets of component sockets, including the most common 20-pin and 40-pin configurations. The reference device is inserted into one side; you put the device to be tested into the other side. Switches on the module correspond to IC pin numbers. Pressing a switch connects the same contact on each component into the test circuit. For example, depressing the switch labeled 39 will activate pin number 39 on each IC. Jumper wires also may be used to set up a desired configuration.

Continued on page 37

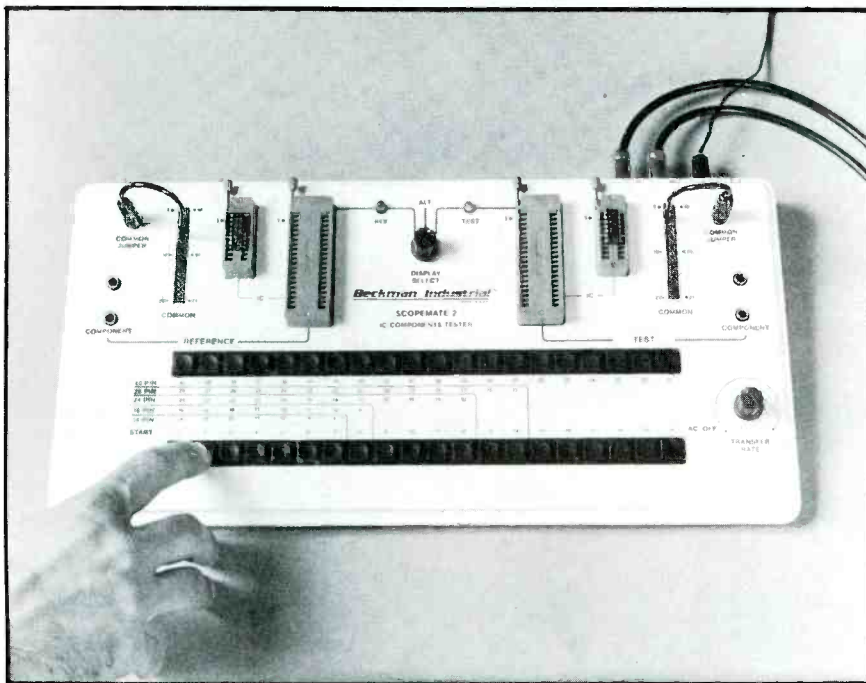

Figure 3. The add-on test module is really two test rigs in one. Two sets of sockets permit comparison testing components and ICs up to 40 pins. A known-good, or reference, component is inserted on the left; the device under test is inserted on the right. Switches permit selective activation of pin positions on each device, and test voltage is applied internally. Module outputs go to X-Y inputs on the scope.

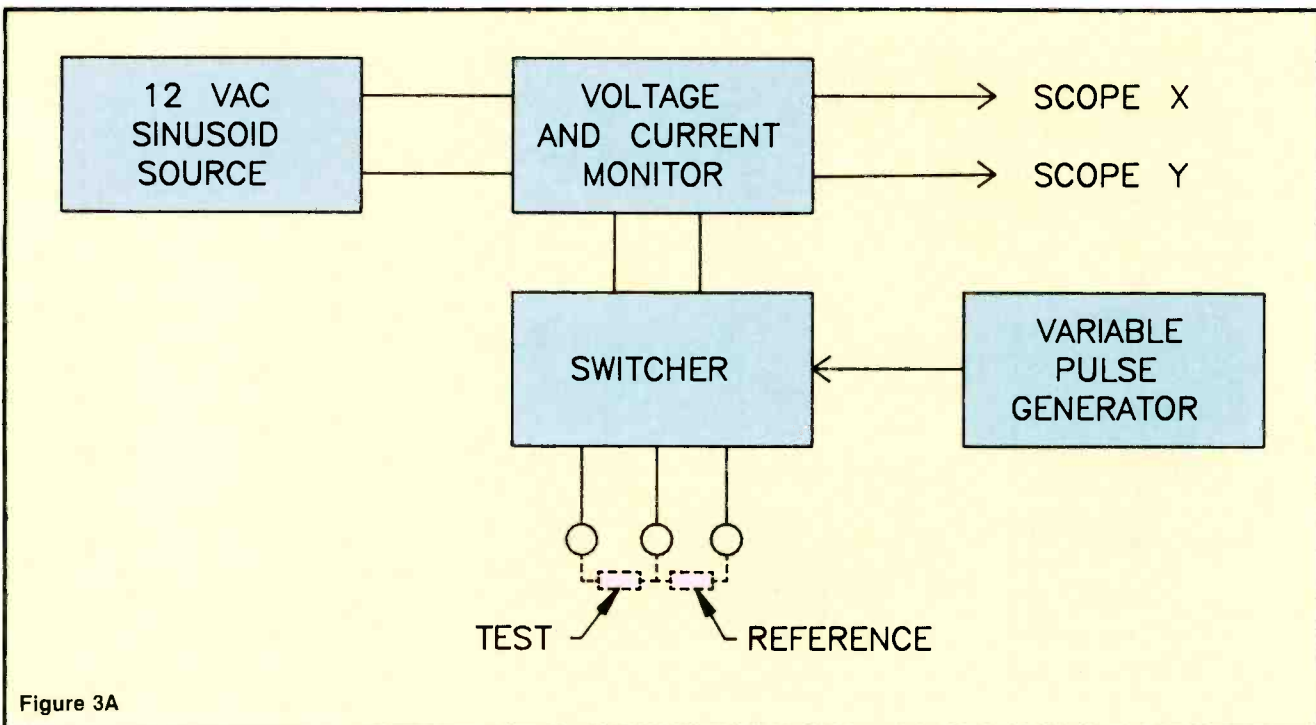

Figure 3A

This schematic is for the use of qualified technicians only. This instrument contains no user-serviceable parts.

Schematic B (BO1 version)

Video, chroma, deflector, VIR secondary contacts

GE
HP chassis

Video, chroma

The other portions of this schematic may be found on other Profax pages.

Use of substitute replacement parts that do not have the same safety characteristics as recommended in factory service information may create shock, fire, excessive x-radiation or other hazards.

Product safety should be considered when component replacement is made in any area of a receiver. The shaded areas of the schematic diagram designate the components in which safety is of special significance. It is recommended that only exact cataloged parts be used for replacement of these components.

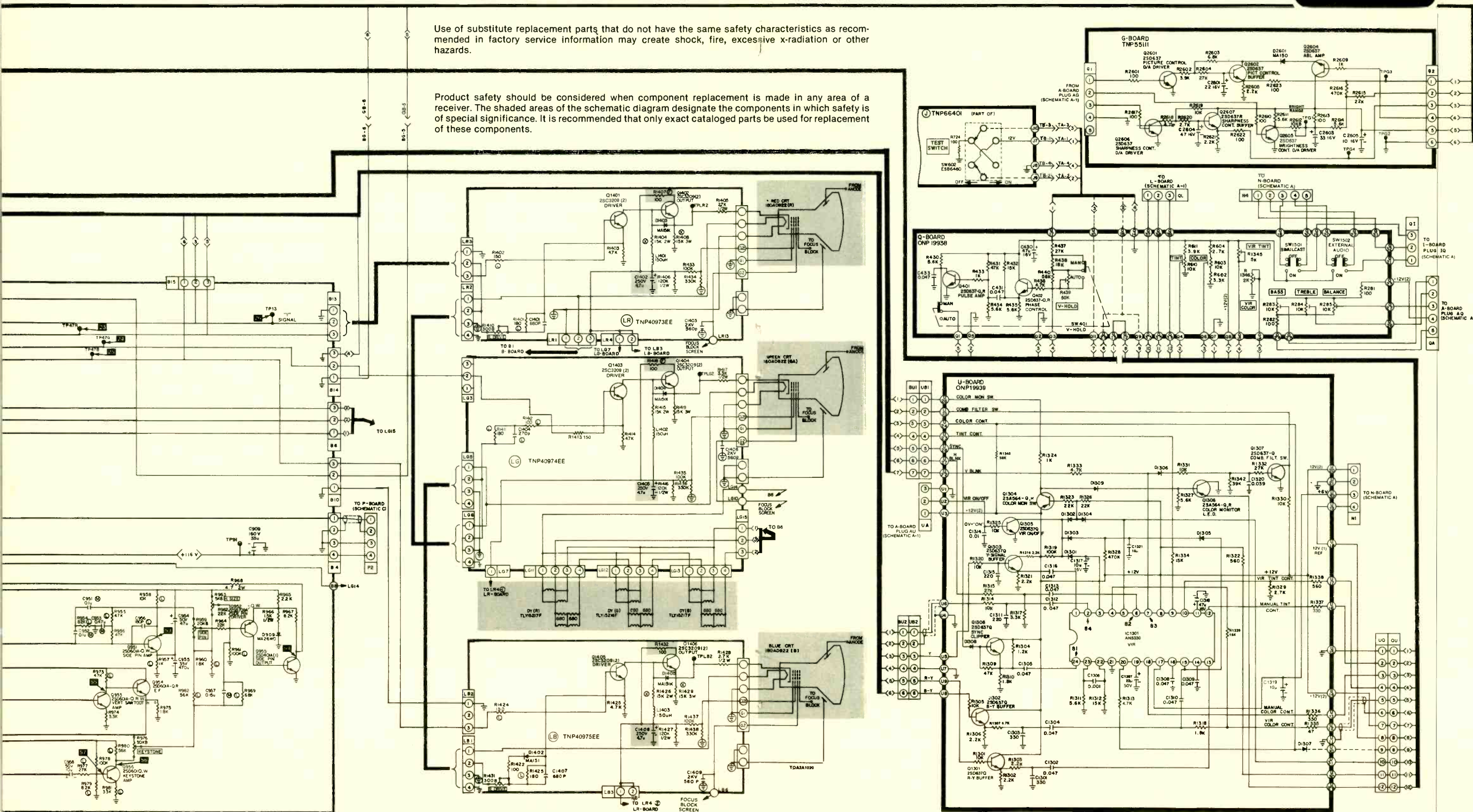

The other portions of this schematic may be found on other Profax pages.

MODIFICATIONS MARKED IN RED WERE MADE TO ELIMINATE AUDIO HUM

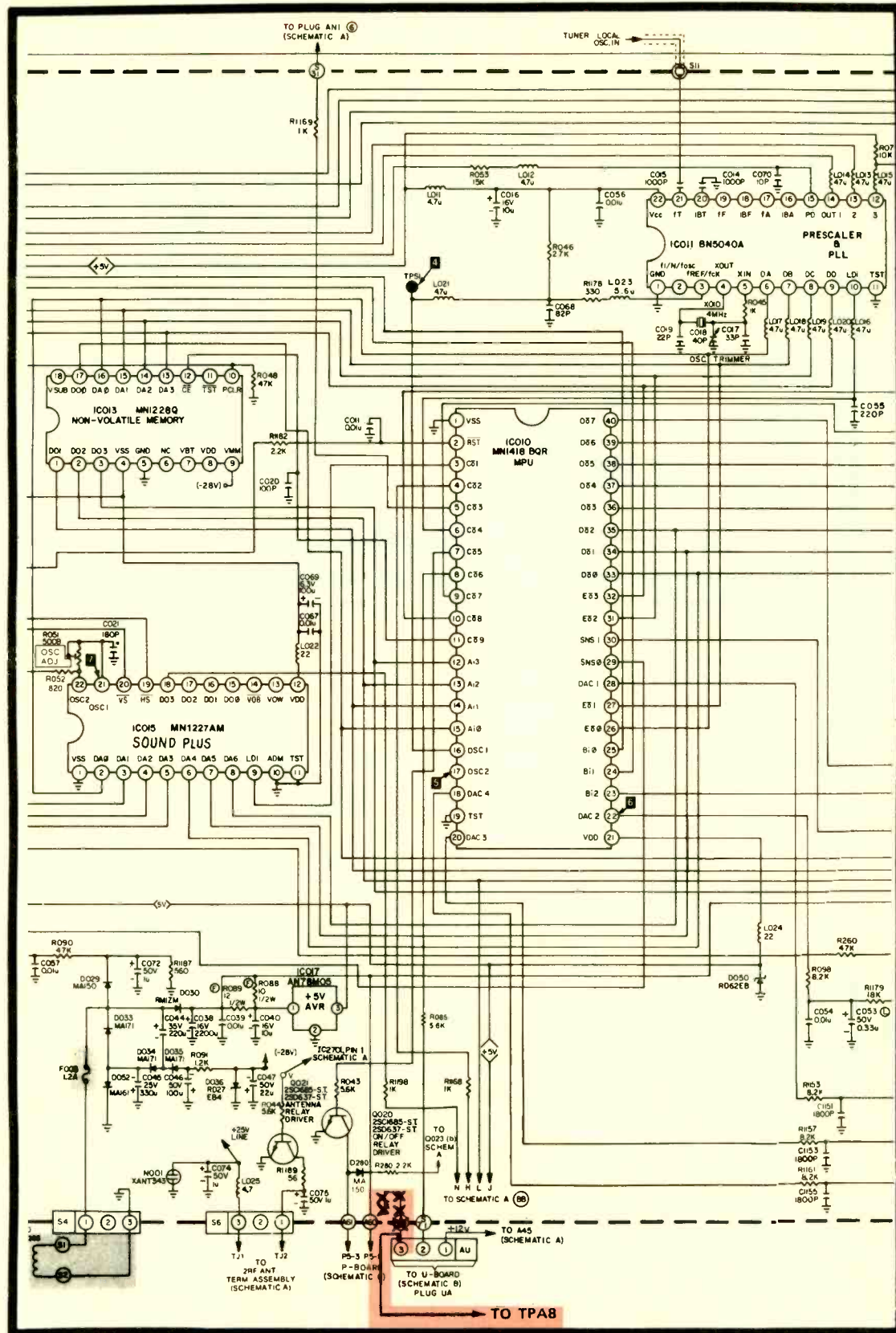

Tuner, IF, audio-video switching, Sound Plus, audio output

MODIFICATIONS MARKED IN RED WERE MADE TO ELIMINATE AUDIO HUM

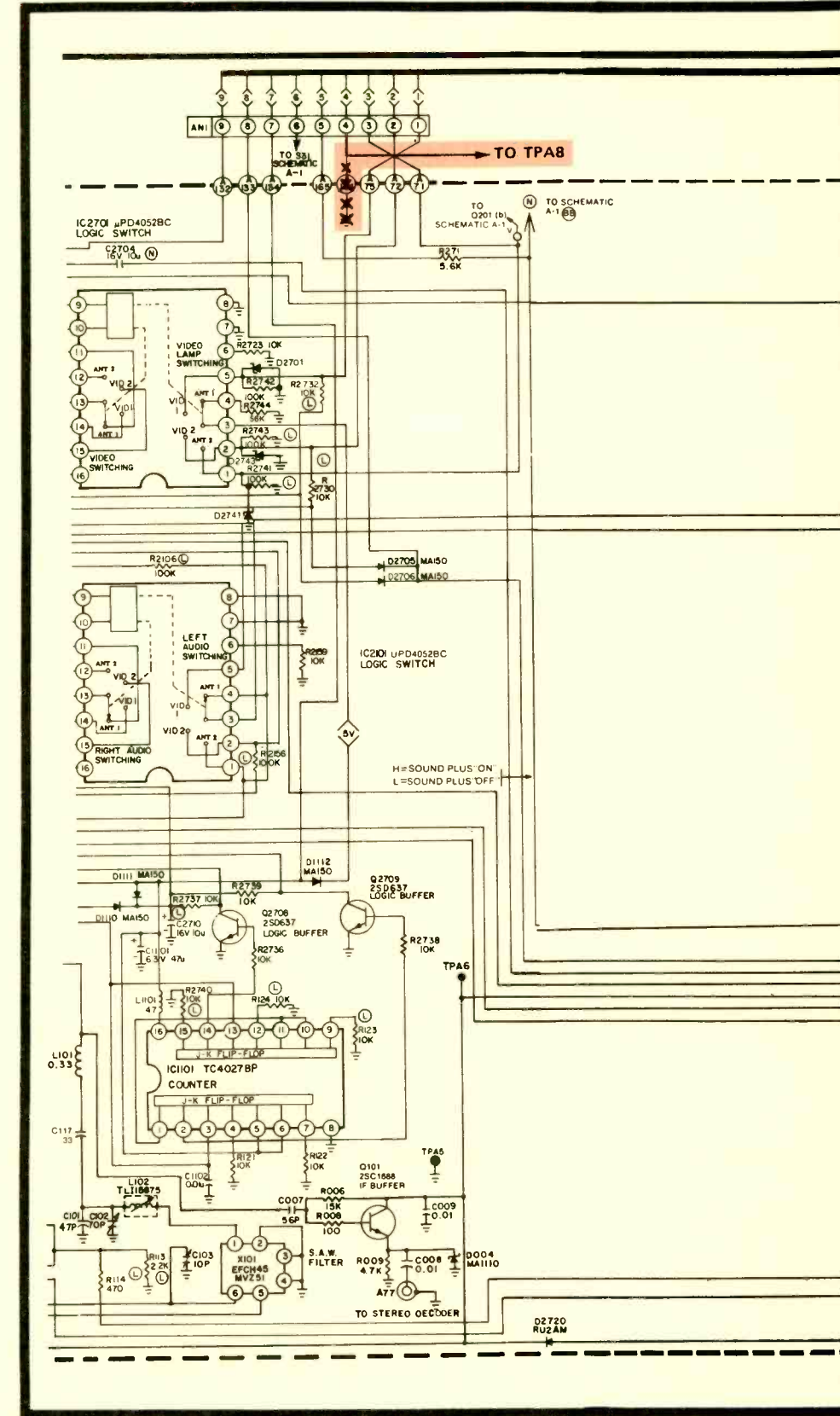

Product safety should be considered when component replacement is made in any area of a receiver. The shaded areas of the schematic diagram designate the components in which safety is of special significance. It is recommended that only exact cataloged parts be used for replacement of these components.

Use of substitute replacement parts that do not have the same safety characteristics as recommended in factory service information may create shock, fire, excessive x-radiation or other hazards.

This schematic is for the use of qualified technicians only. This instrument contains no user-serviceable parts.

The other portions of this schematic may be found on other Profax pages.

Product safety should be considered when component replacement is made in any area of a receiver. The shaded areas of the schematic diagram designate the components in which safety is of special significance. It is recommended that only exact cataloged parts be used for replacement of these components.

Use of substitute replacement parts that do not have the same safety characteristics as recommended in factory service information may create shock, fire, excessive x-radiation or other hazards.

This schematic is for the use of qualified technicians only. This instrument contains no user-serviceable parts.

The other portions of this schematic may be found on other Profax pages.

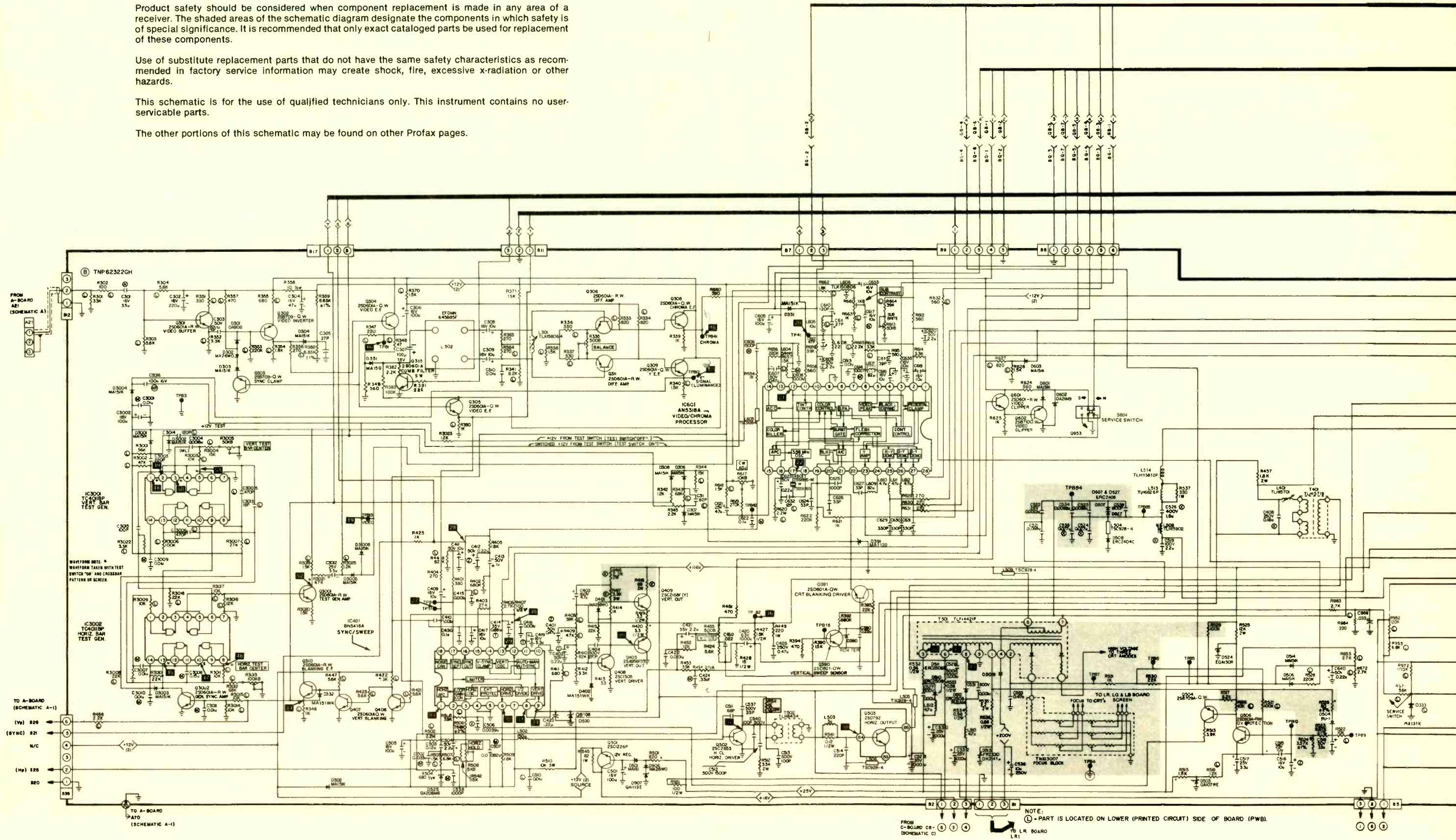

Schematic A (partial)

Tuner, IF, audio-video switching, Sound Plus, audio output

This schematic is for the use of qualified technicians only. This instrument contains no user-serviceable parts.

The other portions of this schematic may be found on other Profax pages.

Product safety should be considered when component replacement is made in any area of a receiver. The shaded areas of the schematic diagram designate the components in which safety is of special significance. It is recommended that only exact cataloged parts be used for replacement of these components.

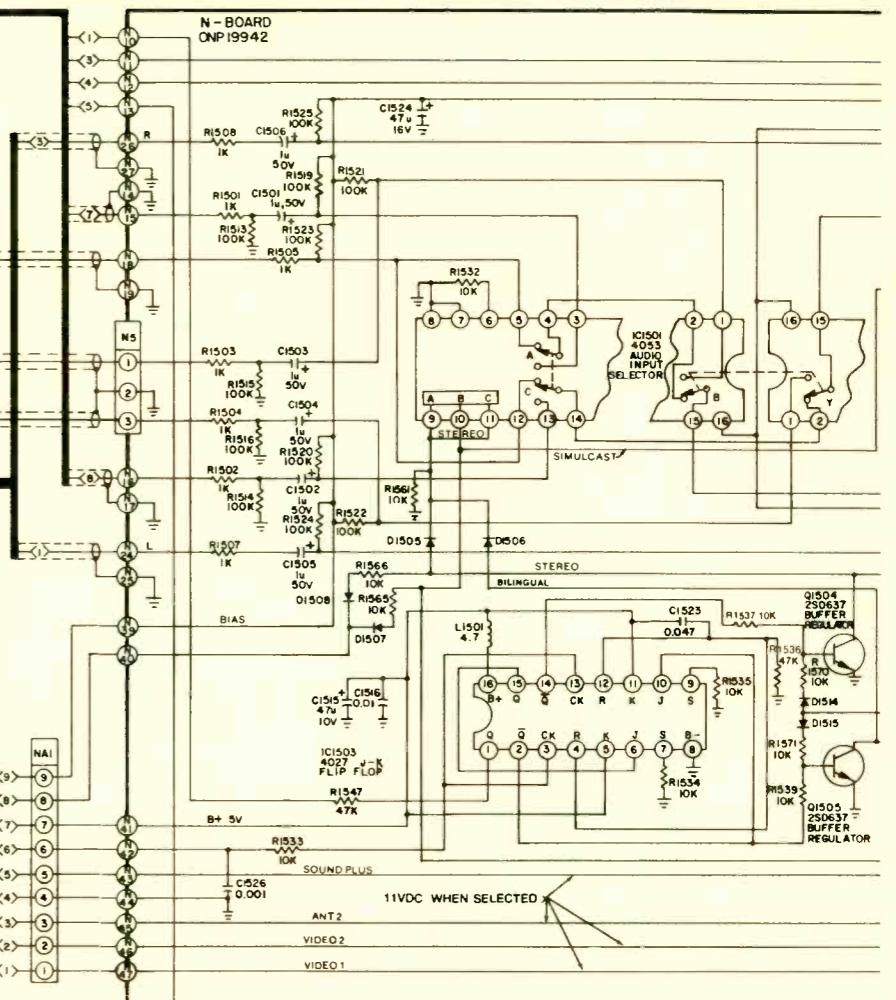
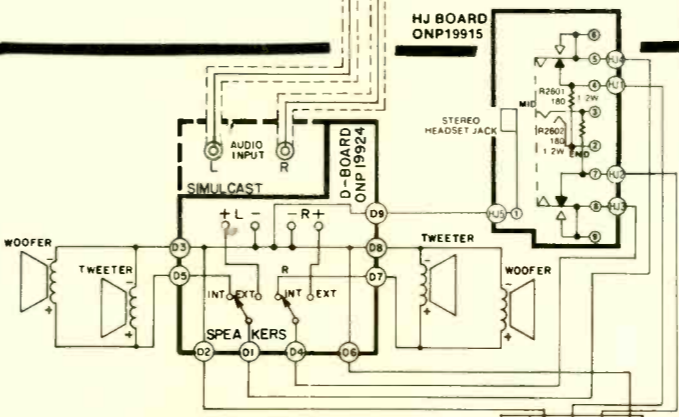
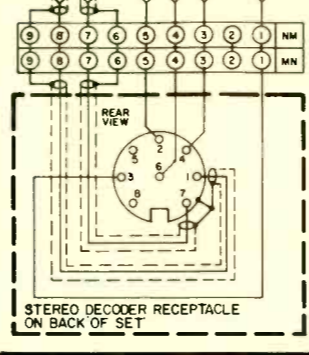
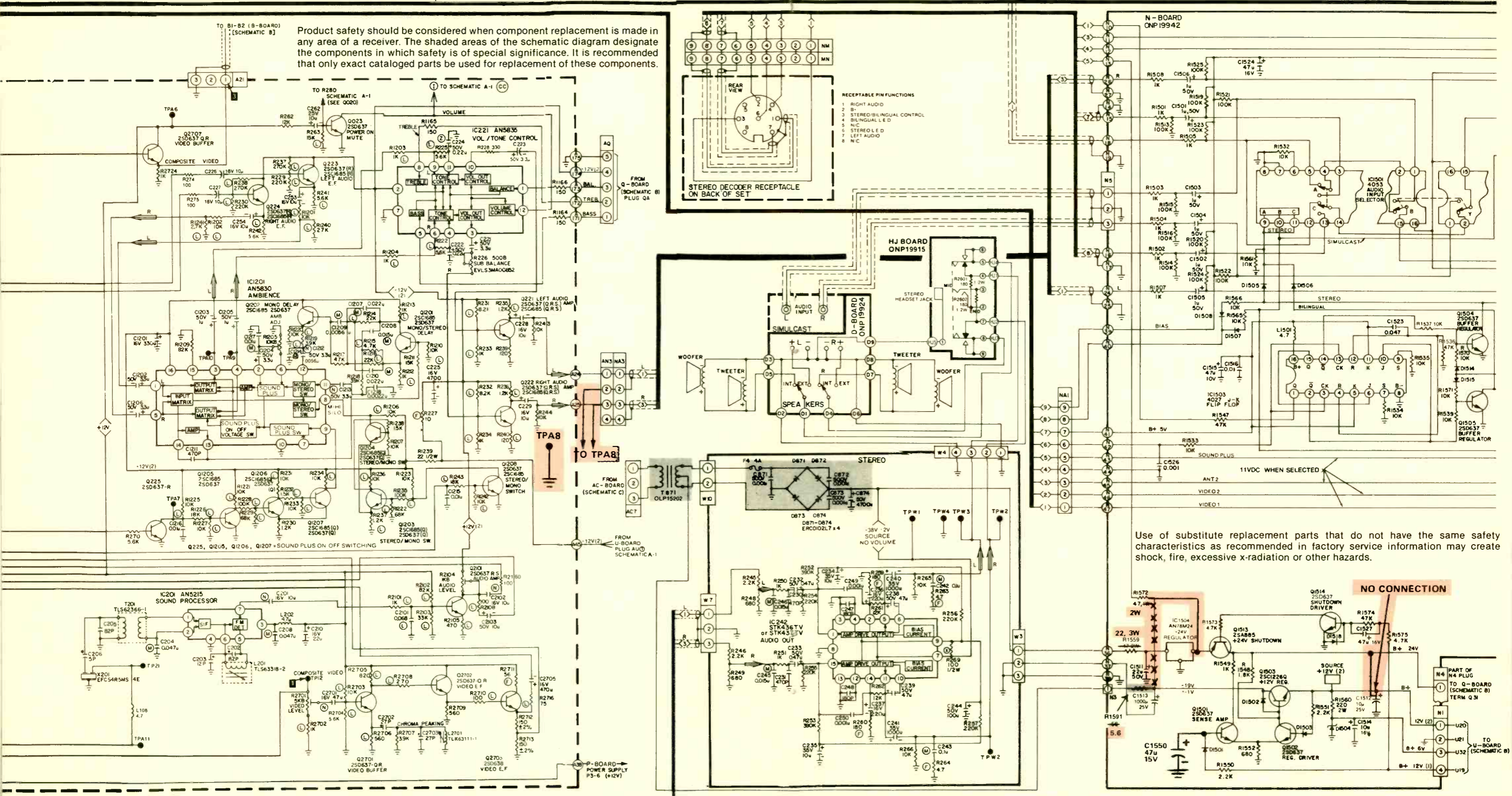

Use of substitute replacement parts that do not have the same safety characteristics as recommended in factory service information may create shock, fire, excessive x-radiation or other hazards.

MODIFICATIONS MARKED IN RED WERE MADE TO ELIMINATE AUDIO HUM

MODIFICATIONS MARKED IN RED WERE MADE TO ELIMINATE AUDIO HUM

Continued from page 28

Instead of inserting ICs in the sockets on the unit, you can use extender leads to connect boards to the test module, as shown in Figure 4. Types of extenders include DIP clips with ribbon cables for connection to on-board ICs and single leads with mini-clips.

With this setup, the test voltage is applied to unpowered components. Again, component parts may be inserted into sockets on the test module, or extender leads may be used for on-board connections. With the module's switches, you can select and display individual signatures of either component and any combination of pins. Obviously, for valid comparison, the components have to be identical and the test configuration has to be the same on both sides.

Applications

Comparison testing can be used to screen the majority of repair and quality-control problems, including short, leak, open and bonding problems. Any significant difference in the two signatures indicates failure in the device being tested. It's a straightforward, strictly *go* or *no-go* determination. There shouldn't be any guesswork involved.

Note that this is not functional or performance testing. You're injecting a low-power sine wave, not signals encountered in normal operation. You're not evaluating rise-times or looking for marginal performance. Also, intermittent problems may not show up. Instead, you're simply applying a known test voltage (with Scopemate 2, up to 14V RMS at 300 μ A to comparable, unpowered devices. It really doesn't make a difference that this is not nominal operating power, as long as the same current-limited sine wave is applied to identical points on each device. This is essentially the same type of test that is applied by more expensive semiconductor curve tracers that apply the same function to a device at varying voltages. Varying the voltage isn't necessary for comparison testing, because all you need is a reference having known parameters.

If there's a trick to comparison

With the module's switches, you can select and display individual signatures of either component or any combination of pins.

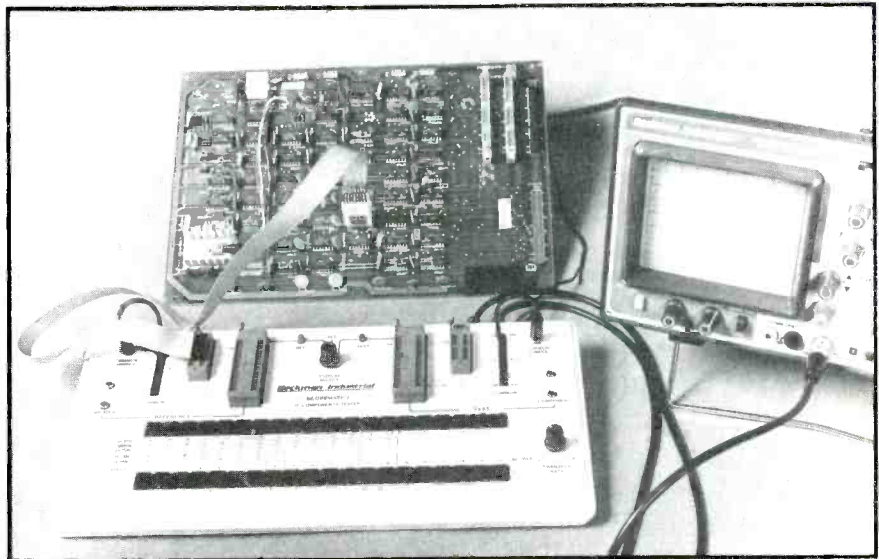

Figure 4. Cables may be used to connect IC sockets on the test module to DIP clips for in-circuit testing of unpowered boards. In this way, ICs may be tested safely and reliably without desoldering.

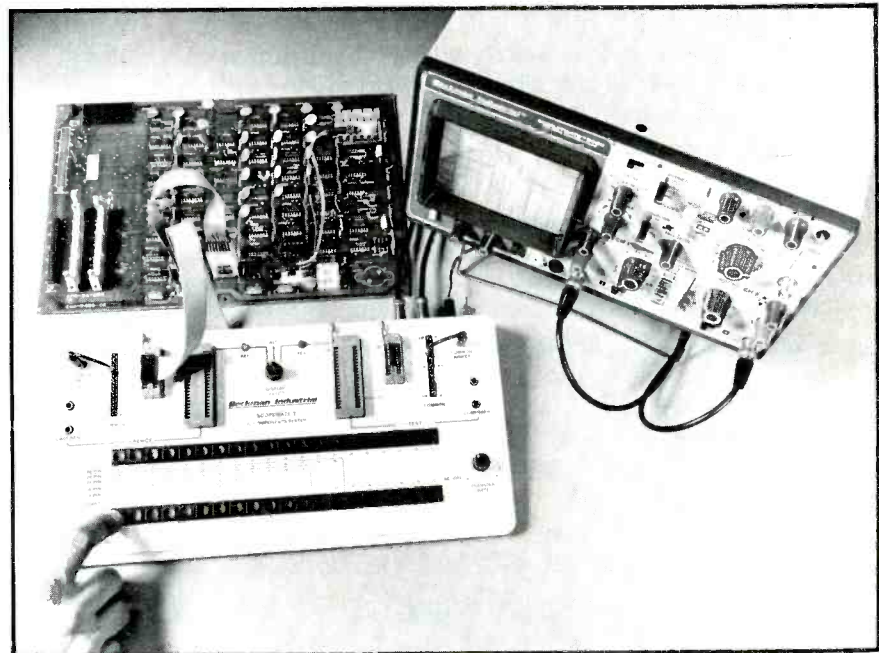

Figure 5. The test unit shown here may be used with any dual-channel scope that has X-Y inputs. Because the low-current test voltage has a frequency of 50Hz to 60Hz, the bandwidth of the scope is not critical. In accept/reject testing, all necessary evaluations can be made with a low-cost scope.

Exclusive, triple patented dynamic cap and coil analyzing . . . guaranteed to pinpoint your problem every time or your money back



with the all new LC75 "Z METER 2"
Capacitor Inductor Analyzer
Patented \$995

The "Z METER" is the only LC tester that enables you to test all capacitors and coils dynamically — plus, it's now faster, more accurate, and checks Equivalent Series Resistance (ESR) plus small wire high resistance coils.

- Eliminate expensive part substitution and time-consuming shotgunning with patented tests that give you results you can trust every time. Test capacitor value, leakage, dielectric absorption, and ESR dynamically; with up to 600 volts applied for guaranteed 100% reliable results — It's exclusive — it's triple patented.
- Save time and money with the only 100% reliable, in- or out-of-circuit inductor tester available. Dynamically test inductors for value, shorts, and opens, automatically under "dynamic" circuit conditions.
- Reduce costly parts inventory with patented tests you can trust. No more need to stock a large inventory of caps, coils, flybacks, and IHVTs. The "Z METER" eliminates time-consuming and expensive parts substituting with 100% reliable LC analyzing.
- Turn chaos into cash by quickly locating transmission line distance to opens and shorts to within feet, in any transmission line.
- Test troublesome SCRs & TRIACs easily and automatically without investing in an expensive second tester. The patented "Z METER 2" even tests SCRs, TRIACs, and High-Voltage Diodes dynamically with up to 600 volts applied by adding the new SCR250 SCR and TRIAC Test Accessory for only \$148 or FREE OF CHARGE on Kick Off promotion.

To try the world's only Dynamic LC Tester for yourself, CALL TODAY, WATS FREE, 1-800-843-3338, for a FREE 15 day Self Demo.



SENCORE

3200 Sencore Drive
Sioux Falls, SD 57107
605-339-0100 In SD Only

innovatively designed with your time in mind

**CALL TODAY
WATS FREE
1-800-843-3338**

Circle (10) on Reply Card

testing with a scope, it's establishing how much variation from the reference signature can be tolerated. Subtler differences merely may indicate variations within spec or may indicate degradations in performance that eventually will show up as failures. Knowing how to interpret the displays requires some skill in waveform analysis, as discussed later in this article. However, once these parameters are set, even less-skilled operators will be able to spot the failures.

This type of comparison testing can become a general-purpose approach for screening problem devices, both in the field and in the lab. It's particularly attractive for smaller service operations, since the equipment investment is modest (about \$395 for the unit discussed here), and no special test rigs or custom fixturing is required. In fact, simple comparison tests can be just as effective at this level as some more complex ATE tests that require custom programming.

You can apply comparison testing in board-swapping procedures, both in diagnosing failed boards and in verifying that the replacement is good. Or, once a bad component has been found and replaced on a board, you can apply comparison testing to check the repaired board against an operational one. You can also use this setup for incoming tests in the shop to evaluate parts received against known-good ones.

The general-purpose aspect of comparison testing is perhaps its strongest recommendation. If your shop handles either a low volume of boards or a large variety of boards, the same basic setup can be used on all of them. You don't need a custom test fixture for each type of board and bus standard.

Another advantage is to give yourself more time to take care of difficult technical problems. Having established specs for signatures that indicate failures, you

Analyze defective waveforms faster, more accurately, and more confidently — every time . . . or your money back

can assign some basic troubleshooting and quality-control steps to an assistant who is trained to run the comparison tests.

For advanced troubleshooting, though, comparison testing also works on a more sophisticated level. By analyzing differences in component signatures, you can monitor performance and note degradations. Applied in this way, comparison testing can be a valuable diagnostic tool in performing preventive maintenance.

Setup and test procedure

A basic setup for running the comparison tests is shown in Figure 5. Note that with the test module shown, there are no special requirements beyond a dual-trace scope with X-Y capability. One reason for this is that there is no custom interface needed between this unit and the scope. A low-cost scope should serve quite well, because neither the bandwidth nor the accuracy of the scope is critical; the comparisons show relative, not absolute, component behavior.

With this setup, you've got a truly low-cost, general-purpose test configuration. With a scope like the one shown, you can have a complete test rig for less than \$900. For accept/reject testing, there isn't much to be gained by using a more expensive scope. At this level of cost, and particularly if you already have the scopes, you could equip each workstation in your shop for comparison testing of all types of components and unpowered boards.

Power connections are internal within the test unit if you're using the IC sockets. The unit's outputs are connected to the X-Y inputs on the scope. If you're testing components on boards, connections to the scope are the same, but your test probe leads plug into the unit and may terminate in mini-clips or DIP clips for attachment to the boards. Switches on the unit are used to activate corresponding IC pin numbers.

A switch on the test module controls which signature is being displayed. Once the setup is complete, you test the known-good, or reference, device first. Adjust the

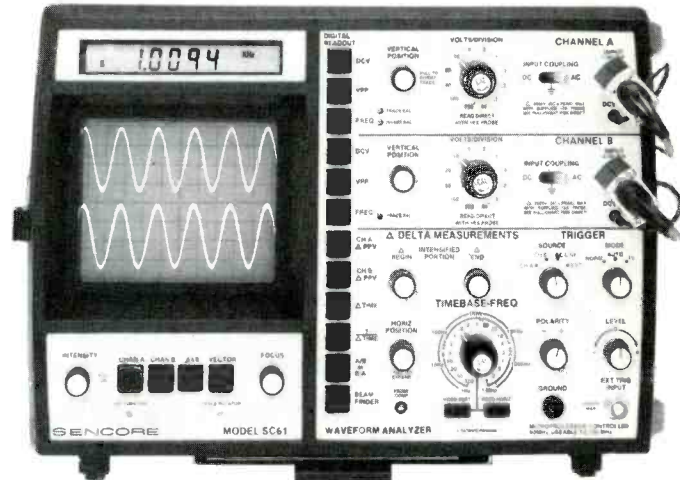

with the SC61 Waveform Analyzer
Patented \$2,995

If you value your precious time, you will really want to check out what the exclusively patented SC61 Waveform Analyzer can do for you. 10 times faster, 10 times more accurate, with zero chance of error.

- **End frustrating fiddling with confusing controls.** Exclusive ultra solid ECL balanced noise cancelling sync amplifiers, simplified controls, and bright blue dual trace CRT helps you measure signals to 100 MHz easier than ever.
- **Accurately and confidently measure waveforms from a tiny 5 mV all the way to a whopping 3,000 V without hesitation with patented 3,000 VPP input protection — eliminates expensive "front end" repairs and costly equipment downtime.**
- **Make only one circuit connection and push one button for each circuit parameter test:** You can instantly read out DC volts, peak-to-peak volts and frequency 100% automatically with digital speed and accuracy. It's a real troubleshooting confidence builder.
- **Confidently analyze complex waveforms fast and easily.** Exclusive Delta measurements let you intensify any waveform portion. Analyze glitches, interference signals, rise or fall times or voltage equivalents between levels; direct in frequency or microseconds.
- **Speed your digital logic circuit testing.** Analyzing troublesome divide and multiply stages is quicker and error free — no time-consuming graticule counting or calculations. Simply connect one test lead to any test point, push a button, for test of your choice, for ERROR FREE results.

To see what the SC61 can do for your troubleshooting personal productivity and analyzing confidence, CALL TODAY, WATS FREE, 1-800-843-3338, for a FREE 15 day Self Demo.



SENCORE

3200 Sencore Drive
Sioux Falls, SD 57107
605-339-0100 In SD Only

innovatively designed with your time in mind

**CALL TODAY
WATS FREE
1-800-843-3338**

Now test and restore every CRT on the market . . . without ever buying another adaptor socket or coming up embarrassingly short in front of your customer . . . or your money back



**with the new improved CR70 "BEAM BUILDER"
Universal CRT Tester and Restorer
Patented \$995**

Have you ever?

- **Thrown away a good TV CRT, data display CRT, or scope CRT** that could have been used for another two or three years because you had no way to test or restore it?
- **Lost valuable customers because you advised them that they needed a new CRT** when another technician came along and restored the CRT for them?
- **Lost the profitable extra \$35 or more** that you could have gotten for restoring a CRT while on the job and locked in the profitable CRT sale later?
- **Avoided handling profitable trade-ins or rentals** because you were afraid you'd have to replace the picture tube when you could have restored it?
- **Had a real need to test a CRT on the job, but didn't have the right adaptor socket or setup information** in your setup book?

If any of these things have happened to you, **CALL TODAY, WATS FREE, 1-800-843-3338**, for a **FREE 15 day Self Demo.**



SENCORE

3200 Sencore Drive
Sioux Falls, SD 57107
605-339-0100 In SD Only
innovatively designed with your time in mind

**CALL TODAY
WATS FREE
1-800-843-3338**

scope for best display. If your scope has a *beam-finder* feature, you can bring the trace into view with a touch of a button. Remember that the scope settings are not critical, as long as you can see the trace characteristics clearly. Once you have a good display from the reference source, don't change it when you've switched to the test source. Compare traces by switching from one source to the other. A selector on the switcher unit will permit you to alternate between traces, at adjustable rates, to display the signature of either device.

Diagnosis

Interpretation of the traces should be simple and obvious. Differences indicate a malfunction in the device under test. For accept/reject testing, the nature of the difference won't be critical.

Note that the test operator doesn't even have to know how the circuit being tested operates. The only requirement is that the power and test probes must be applied to identical points on each component. Of course, as a qualified technician, you should specify the points to be tested and any allowable differences in waveforms. However, once test procedures are established, the operator has no need of a schematic or of any other reference but the display on the scope.

Waveform analysis

As stated previously, you can proceed to a more sophisticated level of testing by analyzing the nature and magnitude of any difference in the signatures. Shapes and directions of deviation can indicate the type of failure, as shown in Figure 6. Each pair of display photographs represents a comparison test of a different type of component. Signatures of reference devices are shown on the left, and those of devices being tested appear on the right. Note that, in each case, the differences

Circle (12) on Reply Card

are significant, indicating failures.

The voltage/current relationships displayed indicate device behavior in detail and can help pinpoint the nature of any breakdowns. Some examples are:

Digital IC. In a good device, the current and voltage legs of the trace should be perfectly linear. In a failed device, a spike appearing at a junction change would indicate a broken junction, perhaps causing oscillation. Absence of a voltage leg would result in an indistinct change from voltage to current and a gently sloping trace, indicating leakage. If the junctions are sharp but the legs are angular, there is resistance at the input, and the device is not turning on fast enough.

Flip-flop. The signature of each pin of a flip-flop will exhibit the same characteristics as that of a diode. Normal and abnormal diode signatures are shown in Figure 6.

Power transistor. A typical problem in power transistors is excessive collector-emitter leakage. This shows up in the signature as a vertical line (if shorted) or as a loss of the sharp *knee* seen in the normal signature.

Op-amp. Failures in hybrid components are obvious immediately. The irregular shape of the output leg indicates a malfunction.

Capacitor. A good capacitor should have an elliptical signature that is clean and regular. Irregularities in what should be a smooth curve indicate that dielectric properties are breaking down, probably causing noise in the circuit. The signature of a defective capacitor also may be unstable.

Resistor. The signature of a resistor should be a gently sloping, linear trace. Any irregularities indicate failure.

Training and education

The relative ease of comparison testing, combined with its graphic display, make it an excellent tool for training and education. Each type of component or circuit pro-

Walk "tough dog" troubles out of any TV & VCR in half the time . . . or your money back



with the exclusive, patented,
VA62 Universal Video Analyzer . . . \$3,295

Would you like to?

- **Reduce analyzing time:** Isolate any problem to one stage in any TV or VCR in minutes, without breaking a circuit connection, using the tried and proven signal substitution method of troubleshooting?
- **Cut costly callbacks and increase customer referrals** by completely performance testing TVs & VCRs before they leave your shop? Own the only analyzer that equips you to check all standard and cable channels with digital accuracy? Check complete, RF, IF, video and chroma response of any chassis in minutes without taking the back off the receiver or removing chassis plus set traps dynamically right on CRT too? Simplify alignment with exclusive multiburst pattern.
- **Reduce costly inventory from stocking yokes, flybacks, and other coils and transformers, for substitution only,** with the patented Ringing Test. Run dynamic proof positive test on any yoke, flyback, and integrated high voltage transformer . . . in-, or out-of-circuit?
- **Protect your future** by servicing VCRs for your customers before they go to your competition? Walk out "tough dog" troubles in any VCR chrominance or luminance circuit — stage by stage — to isolate problems in minutes? Have a proof positive test of the video record/play heads before you replace the entire mechanism?
- **Increase your business** by meeting all TV and VCR manufacturers' requirements for profitable warranty service work with this one universally recommended analyzer.

To prove it to yourself, CALL TODAY, WATS FREE, 1-800-843-3338, for a FREE Self Demo . . . or learn how the VA62 works first by calling for your free simplified operation and application instruction guide, worth \$10.00.



SENCORE

3200 Sencore Drive
Sioux Falls, SD 57107
605-339-0100 In SD Only

innovatively designed with your time in mind

**CALL TODAY
WATS FREE
1-800-843-3338**

Circle (13) on Reply Card

May 1986 *Electronic Servicing & Technology* 41





	REFERENCE DEVICE GOOD	TESTED DEVICE BAD
CAPACITOR		
CIRCUIT OPEN/SHORT		
DIODE		
IC		
OP AMP		
RESISTOR		
TRANSISTOR		

Figure 6. Signatures of good (right) and bad (left) devices are shown in this series of comparison tests. Any significant difference from the known-good reference indicates a failed device.

duces a signature of distinctive shape. Transitions in voltage/current relationships illustrate electronic functions graphically. You can actually see what the devices are doing.

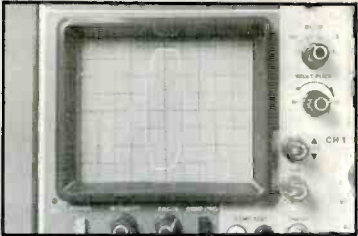
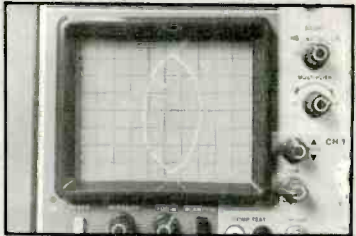
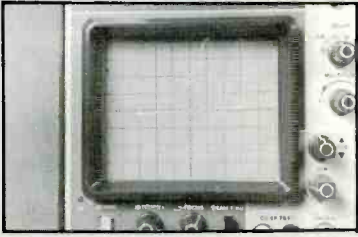
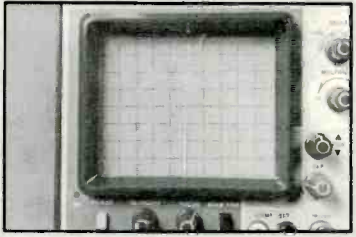
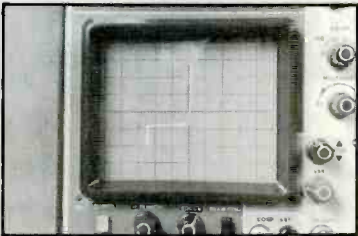
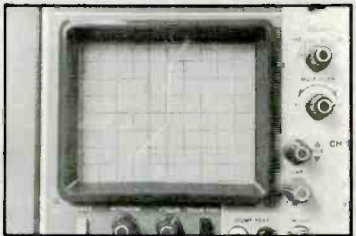
Analyzing the signatures of failed and marginal components points up the causes of breakdowns, as you can see from the examples in Figure 6. So, looking at differences in waveforms is an exceptionally good way to demonstrate the basics of electronic theory in the classroom. Trainees and students can observe both the normal operational characteristics of different components and circuits, as well as what happens to these characteristics as devices degrade and eventually fail.

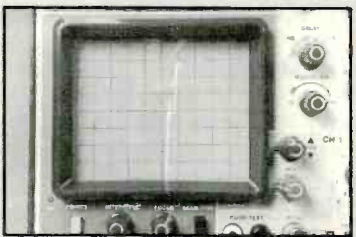
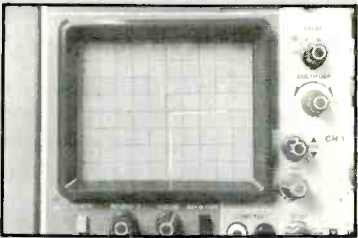
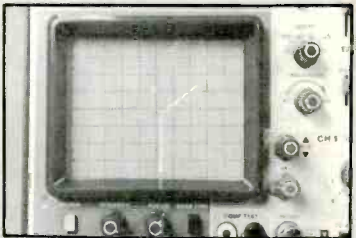
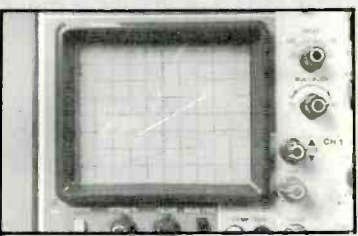
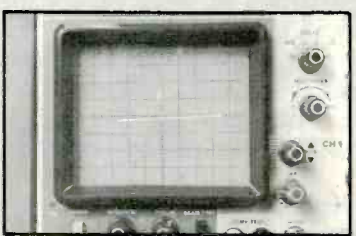
The relatively low cost of the entire setup makes this approach practical within tight training and education budgets. Minimal training time for accept/reject testing, typically less than an hour even for

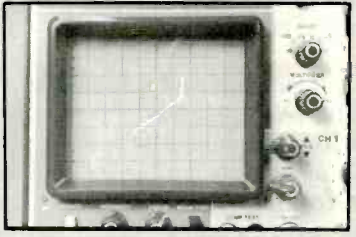
an apprentice, keeps training costs down and reduces the time that skilled technicians must spend with trainees.

Major points to remember

An add-on test module for your scope can greatly extend its usefulness to include comparison testing of all types of components— analog, digital or hybrid. Components may be tested separately or in-circuit on unpowered boards. No special test rigs are needed. Injection and sampling of a current-limited sine wave test voltage produces signatures on the scope display that are distinctive for each type of component and circuit. Visual comparison of these signatures can detect degradations and breakdowns as graphic differences between the traces of good and bad components.

Some technicians claim that they can screen 80% of problems with this setup, either in the field or in

the lab. Quick isolation of failed components, perhaps performed by assistants, can allow skilled technicians to concentrate on more detailed analytical tasks. At a more sophisticated technical level, comparison testing also can be used to spot marginal performance before failure occurs.

In view of the low cost of add-on testers that can be used with any dual-channel scope, this type of comparison testing should become a popular, general-purpose diagnostic technique. It could prove to be a real time- and money-saver for you by decreasing service time and errors, reducing customer down time, saving training costs, reducing spare parts inventory, and cutting board turnaround time.

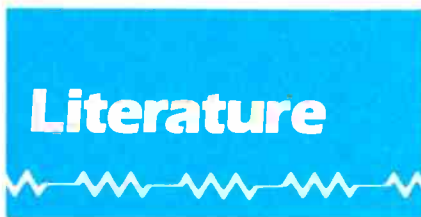

PRint Products International announces its 160-page catalog containing tools and supplies for electronic maintenance and service. Featured in this fully illustrated edition are PACE desoldering and printed circuit board repair products, Huntron test instruments, 3M static control products and PRINT tool cases, as well as many other brand name tools and instruments for repairs in the field or on the bench.

Circle (125) on Reply Card

This 40-page catalog describes and illustrates in color products for high-tech equipment and microcomputer protection. Uninterruptible power supplies, line conditioners, modem protectors, equipment isolators, spike suppressor/filter combination, and ac power interrupters are listed by **ESP Electronic Specialities** in the

complete application specifications.

Included are tutorial sections describing various problem situations and corrective action to be taken. The catalog describes numerous standard, off-the-shelf products, custom designs and Hot Line problem solving.

Circle (126) on Reply Card

Innumerable items from *Atari* to *wire and cable* are listed in the 124-page catalog released by **Electronics Warehouse Corporation**. Computer parts are featured, but expect even more pages devoted to audio, video, test and telephone equipment.

Circle (127) on Reply Card

Falcon Safety Products provides a 16-page illustrated guide on preventive maintenance techniques for computers and other electronic office equipment. The booklet guides the reader through proper preventive maintenance using this company's products.

The new computer owner as well as longtime users of electronic office equipment will find the com-

bination helpful in maintaining computer performance while protecting the life of the equipment. Topics covered include dust removal, static control, print element cleaning, platen restoration, screen and housing cleaning, and safety measures.

Circle (128) on Reply Card

AEG has issued a working document titled "Turn-off Thyristors Correctly Controlled." It includes detailed descriptions of the physical processes involved in turn-on and turn-off operations of turn-off thyristors (sometimes called GTOs) as well as the resultant requirements for correct operation. The description of some technically sophisticated control equipment also gives the circuit designer more detailed practical assistance. A simpler and thus less expensive concept also is presented. A dc actuator and a pulsed inverter for 3-phase rectifiers are described as examples of the use of turn-off thyristors. Heretofore, this kind of information has been available, in detail, only in German.

Circle (129) on Reply Card



In today's competitive test-equipment marketplace, there's a wide variety of oscilloscopes to choose from. Although newer models offer increased portability and many enhanced features, basic scope functions are pretty much the same from one model to the next. The accompanying article describes a type of comparison-test module that can be used with dual-channel oscilloscopes, or scopes that handle inputs from two sources. As the article points out, comparisons that test one component against another don't necessarily require scopes with elaborate features. So, to cover the basics, here's a primer on scope features and terminology.

What does a scope do?

The basic function of any oscilloscope is to measure variations in voltage over a time base. The result is displayed as a curve on a graphic coordinate grid on the face of a CRT. The vertical dimension, or y axis, is the voltage component and the horizontal dimension, or x axis, is the time base, which proceeds from left to right.

The actual display of the voltage curve on the face of the scope's CRT is called a *trace*, and the study of trace characteristics in diagnosing electronic circuitry is called *waveform analysis*.

By itself, an oscilloscope is a passive tester. It measures voltages within powered circuits. To conduct certain types of waveform analysis, a separate signal generator may be used to inject sine- or square-wave test patterns into a circuit under test.

A *component test* feature is found on some scopes. Jacks on the scope provide output of a low-current sine-wave voltage that can be applied across component contacts. In this type of test, the scope becomes an active part of the circuit being tested.

How are scope functions arranged?

The most common types of scopes include *single-channel* and *dual-channel* models. A single-channel scope can accept the input and display the trace from one source. A dual-channel scope can handle two sources and can display either trace, alternate between traces, or display both at the same time. On dual-channel scopes, the same time-base is applied to each channel.

For the type of comparison testing described in the article, a dual-channel scope is required. In this type of testing, the trace from a known-good component, or *refer-*

ence device, is compared visually with that of a suspected-bad component. Separate channels are needed to handle inputs from each source. Causing the display to alternate between the two traces is an especially effective way of detecting any differences. Differences in the traces indicate device failures.

For waveform analysis, the *delayed sweep* feature is useful. Delayed sweep, in effect, is a *snapshot* of one portion of the voltage curve, or a captured time segment from which the trace is refreshed continually by the CRT beam. Using delayed sweep, the voltage component can be amplified so that the technician can home in on a particular portion of the trace to study waveform characteristics in detail. This type of analysis may be necessary to diagnose marginal perform-

Typical ranges are 0.1V to 5V and 5mV to 50mV. Switches on some test probes also affect these ranges, permitting the technician to select multipliers of X1 or X10.

Time/div—This control determines the value of each increment on the x axis of the display. On a dual-channel scope, one time/div setting controls both channels, because the same time-base is applied to each. Typical ranges are 0.1s to 2s, 0.1 μ s to 50 μ s and 0.5 μ s to 50 μ s.

Vert mode—On dual-channel scopes, this set of controls is used to select and display one or both channels, to *alternate* between channels, to *chop* the display, or to invert the polarity of the trace.

Chop—This term refers to the process of manipulating low-frequency waveforms to produce a

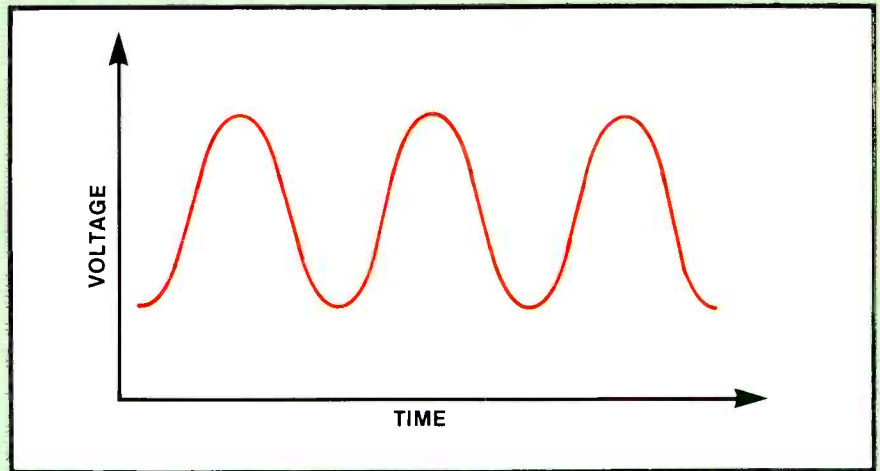

ance, rather than outright failure.

A basic characteristic of scopes that affects price is *bandwidth*, or the range of frequencies to which the scope can respond. Wideband scopes with bandwidths greater than 100MHz are relatively expensive, but may be needed for some RF applications and for analysis of binary data signals, as in digital telecommunications. For the comparison tests described in the article, a low-current, fixed-frequency test voltage of 50Hz to 60Hz is applied to components or boards. This frequency is well within the bandwidths of scopes in relatively modest price ranges. The scope shown in the setup in Figure 5 has a bandwidth of 20MHz.

Basic controls, terminology and selected features

Volt/div—This control determines the value of each increment on the y axis of the display. On a dual-channel scope, two controls will be found, one for each source/channel.

more readable display. The resulting trace shows segments of waveforms, as if chopped.

Delay—On scopes that feature delayed sweep, the delay function controls the time interval between trace samples. Typical ranges are 0.1 μ s to 10 μ s and 0.1 μ s to 10 μ s. (Some scopes also can vary multipliers of this parameter within a range of X1 to X10.)

Trigger mode—Selection of trigger mode determines what condition will initiate the voltage sample displayed. In the NORMal setting, display begins the moment voltage is picked up by the probe. In AUTOmatic mode, the display does not begin until peak voltage is sensed.

Variable holdoff—Function used to contain a stable display when measuring an aperiodic signal, or a waveform of variable frequency.

Beam finder—This convenience feature is used to center the trace within the display at the touch of a button, regardless of any other settings on the scope.

ES&T



Impedance testing methods

By Gregory D. Carey, CET

Many people are surprised to learn that there is no standard method to test capacitors and inductors. The simple construction of these passive components disguises the difficulty in testing their value. It is their reactive nature that causes the problem.

All tests of capacitance or inductance must use an ac test signal because reactance cannot be detected with pure dc. This ac link causes variations among test methods. The variations become

insignificant when testing components with nearly pure inductance or capacitance. But most components have non-ideal conditions that cause them to be frequency dependent. Before looking at the tests available, it's important to understand the non-ideal nature of reactive components.

Lossy components

Reactive components are never ideal. The components with the largest variations from an ideal

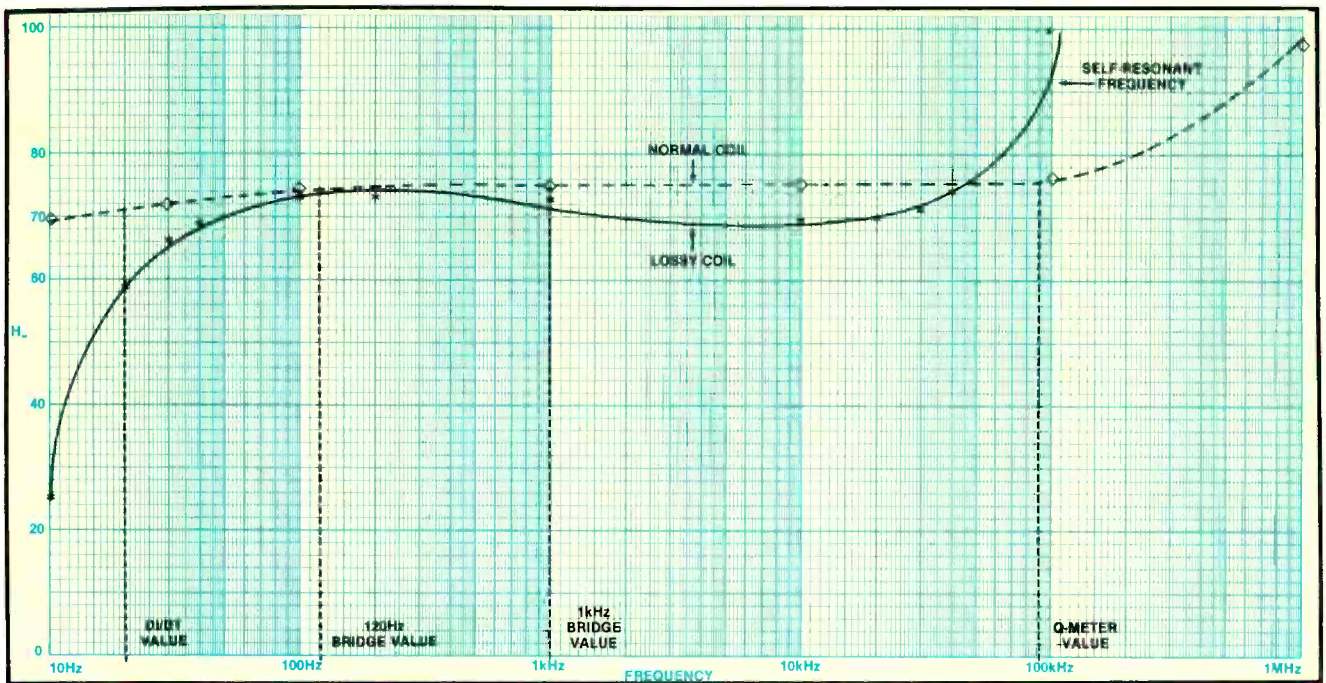

Figure 1. The value vs. frequency characteristics of a lossy coil show why such a coil gives different values for different test methods.

model are often called *lossy*. All components have a self-resonance frequency. The lossy components simply have a much lower self-resonance than low-loss components. Any method of testing value becomes meaningless if it occurs at a frequency at or above the self-resonance frequency.

An ideal capacitor has no resistance or inductance, but all real capacitors have some resistance and some inductance. The two main resistance paths are through

the insulating dielectric (leakage) and in series with the capacitor plates (equivalent series resistance or ESR). Inductance comes from the leads and the metal plates. The resistance and inductance combine with the capacitance value to determine the self-resonant frequency.

The construction of aluminum electrolytic capacitors causes them to have the highest losses and, in turn, the largest variation with frequency. Tantalum capacitors

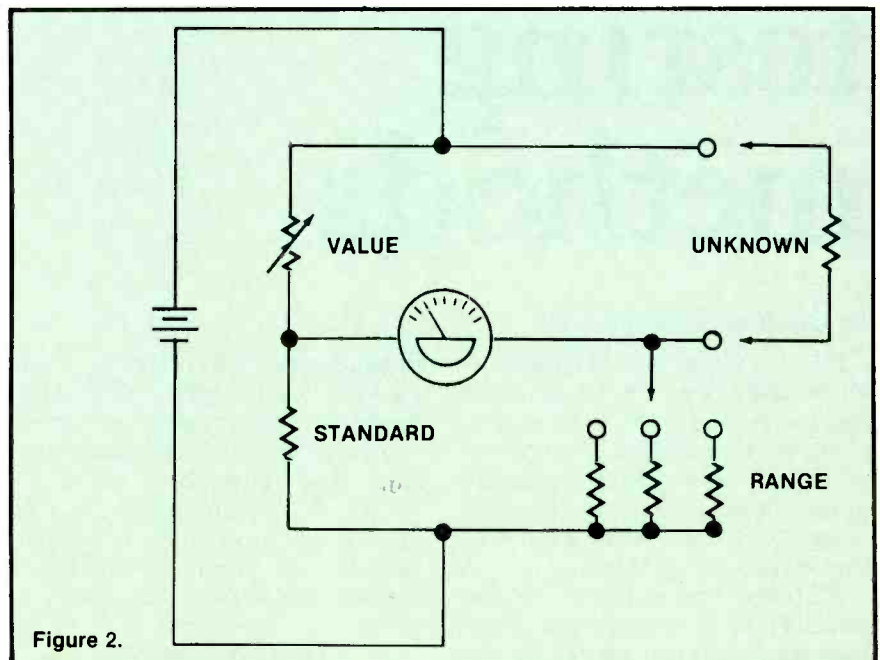

Figure 2.

Figure 2. The R mode of an impedance bridge balances the voltage division of the unknown resistor and selected range resistor against the standard resistor and value potentiometer.

have much lower losses than aluminum electrolytics but are still very lossy compared to ceramic disk or plastic film capacitors. The new *monolithic ceramic* capacitors, which pack extremely large values into very tiny volumes, are also more lossy than conventional disk ceramics.

Similarly, every coil has series and parallel resistance, which dissipate energy. Plus, all coils have some capacitance between windings, causing self-resonance.

Inductors with the highest losses are those using laminated-iron cores, such as chokes or power transformers. The new *micro coils*, which compact extremely high inductance levels into a volume about the size of a $\frac{1}{2}W$ resistor, also cause larger losses than we've seen formerly. These coils have a high dc resistance, because of the hair-fine wire used, and use a high permeability core material that changes in permeability with frequency. The lowest loss coils use an air core, but these coils need a much larger volume for a given inductance value.

The lossy component shows a much greater change in measured value vs. frequency than a similar low-loss component. This also means different value readings

with different test methods. Low-loss components, on the other hand, read nearly the same on all L/C testers. Knowing this can help choose the right type of tester to match the requirements of each testing situation.

The balanced impedance bridge

Many people think of the balanced impedance bridge as the standard way to test reactive components. The only thing that makes this method any more standard than the others is that it has been around a lot longer. But it suffers from several limitations, as you will see later.

The impedance bridge is a variation of the Wheatstone bridge. When testing resistance, as shown in Figure 2, the bridge balances the ratio of a potentiometer and a standard resistor with the unknown resistor and one of several range resistors. When the two voltage-division ratios are identical, both ends of the null-detecting meter have the same voltage potential, causing it to read zero.

When testing capacitance, a standard capacitor is added to one of the legs of the bridge. This capacitor has a potentiometer in series, so we can add resistance to

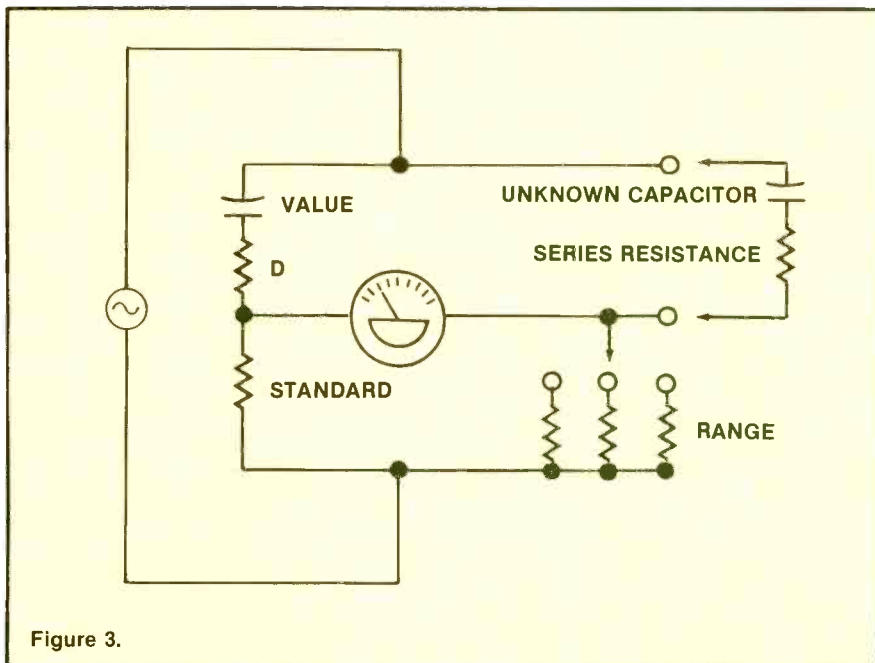

Figure 3.

Figure 3. The C mode of the bridge replaces the standard resistor with the combination of the D control and standard capacitor. The reference signal becomes ac and the null meter becomes ac detecting.

Check Digital IC's in-circuit Fast!

In the field or on the bench. B&K-PRECISION gives you the answers for TTL or CMOS



Model 550 (for TTL) \$395
Model 552 (for CMOS) \$395

New B&K-PRECISION IC Comparator Testers/Logic Monitors put you on the fast track to digital troubleshooting. IC's are tested by comparison to a known good device, allowing you to test hundreds of types with one simple operation.

As logic monitors, they simultaneously indicate the logic states of up to 20 IC pins. No need to check pins singly with a logic probe.

Tests most 14 to 20 pin, 54 and 74 Series TTL (Model 550) or 4000 and 74C Series CMOS (Model 552) devices.

- Convenient one button testing
- Reverse polarity and overvoltage protection
- Uses power from equipment under test
- Memory stores short duration pulses and intermittent events
- Zero insertion force reference IC socket
- LED at each IC pin identifies where fault exists
- Includes 16 and 20 pin DIP clips
- Compact hand-held size

Available from stock at your local B&K-PRECISION distributor. For more information contact your distributor or:

BK PRECISION
DYNASCAN
CORPORATION

6460 West Cortland Street
Chicago, Illinois 60635 • 312/889-9087

International Sales, 6460 W. Cortland St., Chicago, IL 60635
Canadian Sales: Atlas Electronics, Ontario
South and Central American Sales,
Empire Exporters, Plainville, NY 11803

Circle (14) on Reply Card

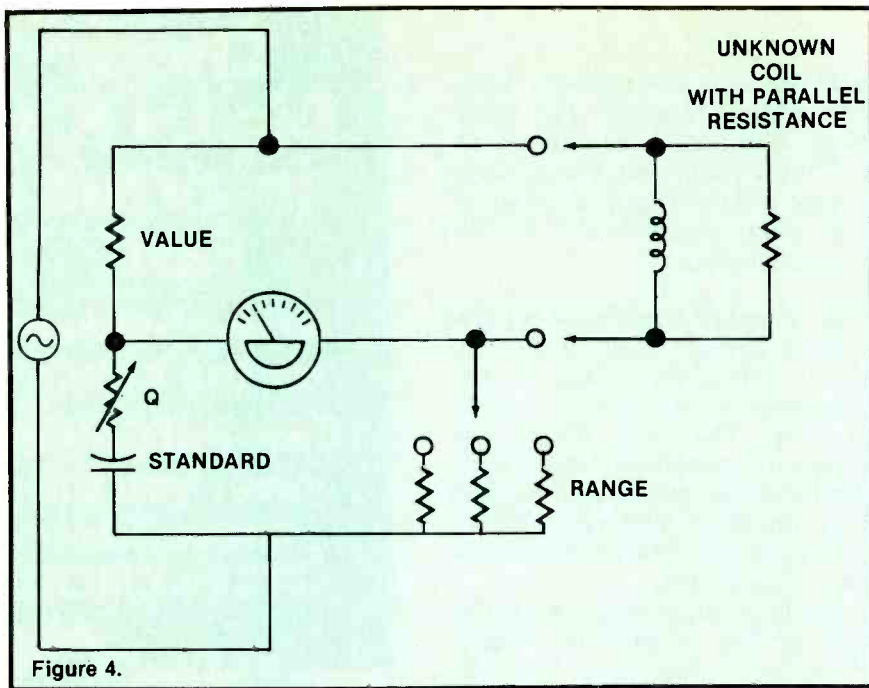

Figure 4.

Figure 4. The L mode moves the standard capacitor to the leg opposite the unknown coil so the reactive capacitor signal cancels the phase of the reactive coil signal.

simulate the resistive part of imperfections in the capacitor under test. This control (called the D control) de-tunes the standard capacitor, so we can balance the phase angles of the bridge signals.

You may suspect that you would replace the standard capacitor with a standard coil as a reference when testing inductors. That's not the case because it's too hard to build a *standard* coil that will not be affected by such variables as temperature, aging or magnetic fields. The same standard capacitor is used as in testing capacitance. To do so, however, the positions of the value potentiometer and the capacitor/potentiometer combination are exchanged, so that the lagging phase of the capacitor voltage cancels the leading phase of the coil under test. The markings on the D dial are then interpreted as Q values, because Q and D are reciprocal of each other.

Limitations of the impedance bridge

The biggest problem with the conventional, manually operated impedance bridge is that it is slow. Between four and eight switches and controls must be jockeyed in different combinations until the null meter reads as close to zero as possible. And, most of these controls interfere with others, meaning moving from knob to knob, and back, to test each component.

Setup is complicated on lossy

components because of a condition known as the *sliding balance*. This causes the null-point of the value control to move when the D knob is turned and vice versa. The only way to find the correct null is to try several different settings of the value knob and re-null the D knob, while observing the relative level on the meter. Since the null moves, this may call for several repeated measurements to get somewhere close to the true value.

An impedance bridge measures inductive and capacitive reactance, instead of true capacitance or inductance. This causes a bridge using one test frequency to give different results than another using a different frequency when testing lossy components. The only way around this is to use the same frequency on both bridges. The calibration of the value and D controls, however, only applies to the single frequency (or group of frequencies) for which the bridge was designed. Formulas are needed to compensate for any other frequency fed into the external generator input jacks.

Finally, impedance bridges produce additional errors when testing polarized electrolytic capacitors. Electrolytic capacitors act like a rectifier and clip part of the ac test signal, causing the value to read low. The cure for this is to use an external dc bias to move the test signal above ground, so the test signal no longer reverse-biases the capacitor.

Quadrature phase testers

The impedance bridge circuit does not lend itself to automatic digital testing because of the many variables that have to be changed for each component test. Many digital L/C meters use a quadrature-phase detector to determine L and C values. These testers use an ac test signal, similar to the bridge, to test the capacitive or inductive reactance of the components. Although the tester uses the same frequency as an impedance bridge, this does not insure identical value readings on lossy components.

The tester applies the test signal to a series combination of the components under test and a reference resistor. Part of the signal across

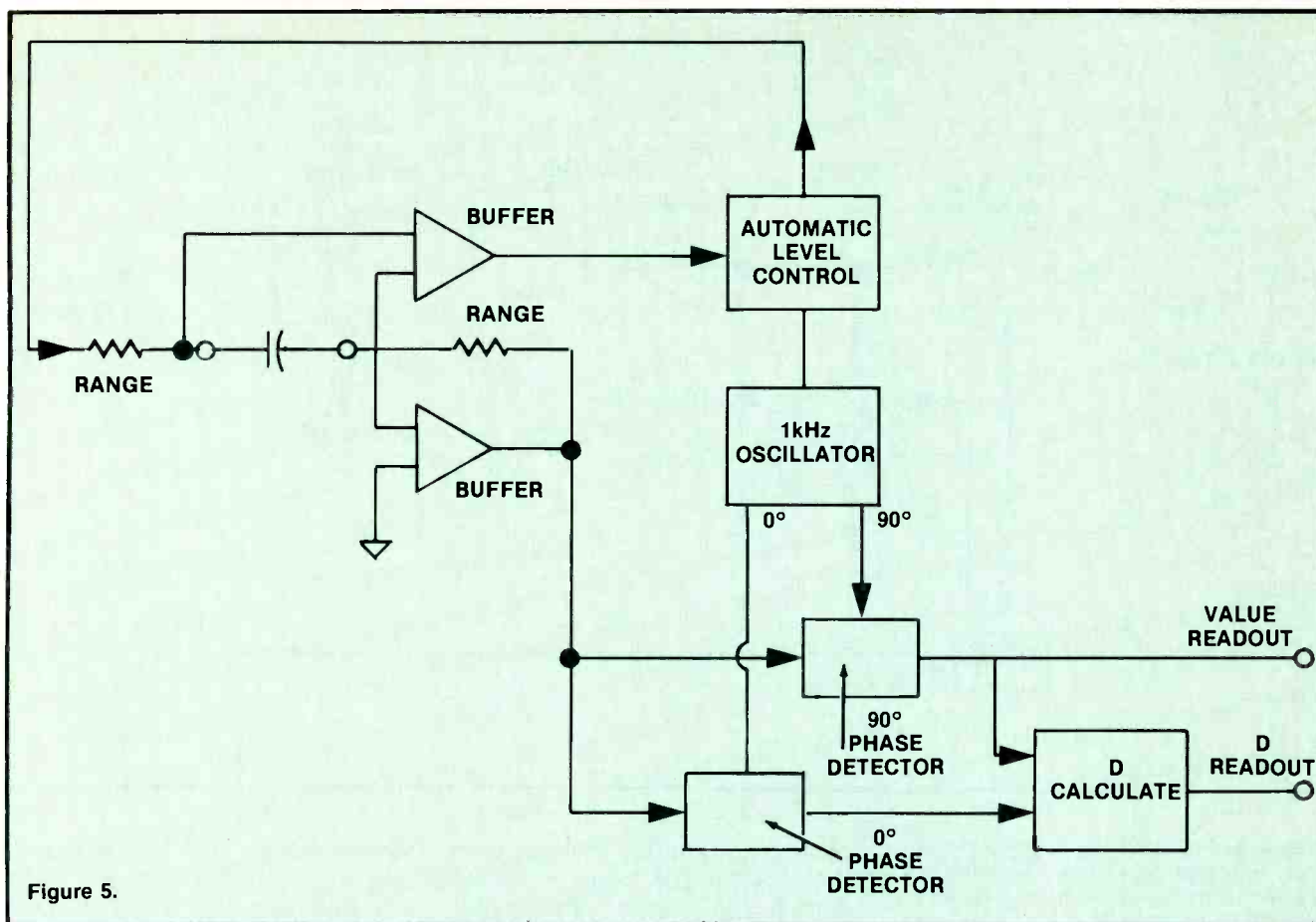

Figure 5.

Figure 5. The quadrature-phase tester detects the amount of signal across the *range* resistor that is 90° shifted from the reference test signal to determine the reactance of the unknown component at 1kHz.

the resistor will be in phase with the generator signal and part will be in quadrature phase (90° shifted) from the generator. The in-phase part of the signal corresponds to the resistive part of the impedance of the unknown component at the chosen test frequency. The quadrature-phase signal corresponds to the reactive part of the impedance.

The block diagram in Figure 5 shows how model 252 digital impedance meter from Electro Scientific Industries (ESI) tests capacitance. The model 252 uses an automatically leveling signal generator to hold the voltage drop across the unknown capacitor at a fixed level. It then uses the quadrature phase detector to measure the current passing through the reference resistor. When testing coils, the voltage across the range resistor is held constant (resulting in a constant current passing through the unknown inductor) while the quadrature-phase detector determines the voltage drop

across the unknown component.

The model 4192A impedance analyzer from Hewlett Packard uses a variation of the quadrature-phase testing method with the additional feature of being able to make tests at any frequency between 5Hz and 13MHz. Its \$11,590 price tag, however, limits it to laboratory applications.

The quadrature phase measurements agree closely with an impedance bridge when testing low-loss components, or components with flat frequency response. The readings on single- or double-frequency testers, however, may vary compared to other methods when testing lossy components. The variation will be the greatest when the component happens to have a self-resonance near the test frequency of the tester, such as with electrolytic capacitors.

R-C time constant tests

Many digital testers determine capacitance with a resistor-capacitor (R-C) time constant. The R-C

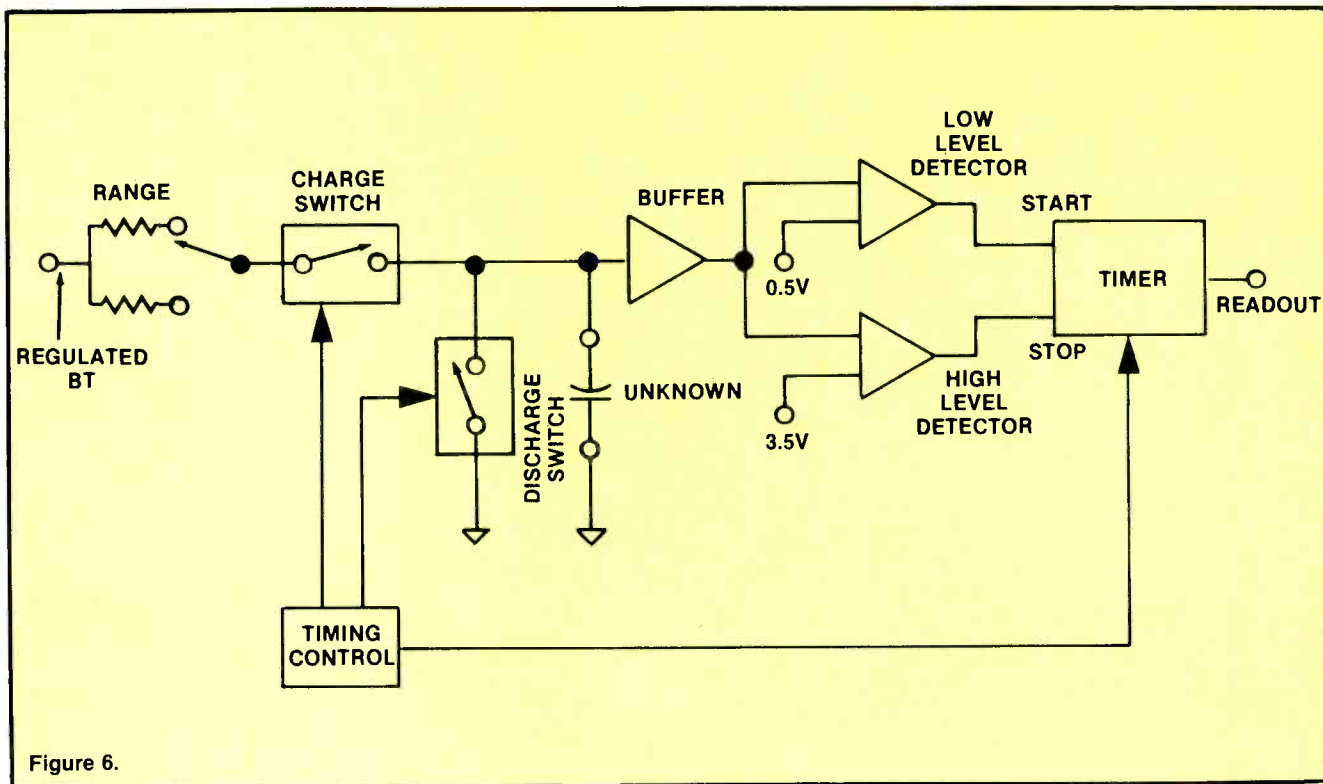

Figure 6.

Figure 6. The R-C system measures the time required to charge the unknown capacitor through a precision resistor to determine capacitance.

system uses simpler circuits than other testers for lower costs. In addition, the circuits need very little power, allowing battery operation of some testers. The R-C time system effectively tests the capacitance at dc, so there is no chance of getting erroneous results because of self-resonance.

As Figure 6 shows, the tester feeds a regulated voltage to the capacitor under test through a precision resistor. A digital timing circuit measures how long it takes for the voltage across the capacitor to vary between two voltage levels. For example, the Sencore Z Meter measures the time needed to change from 0.5V to 3.5V. The charging time and the value of the series charging resistor determine the value.

The R-C measurements agree closely to either of the other methods of testing capacitance when measuring low-loss capacitors. Aluminum electrolytic capacitors generally show a higher value on the R-C testers than on an impedance bridge because of two physical properties.

The first reason for the higher readings is that the water molecules in the electrolyte solution inside the capacitor become resonant near 1,000Hz. This causes the dielectric constant to decrease, resulting in a lower ap-

parent value. This is the reason that many bridges use a 120Hz-test frequency when testing electrolytic capacitors.

The second reason for the higher readings is that the capacitor's equivalent series resistance (ESR) increases as the test frequency becomes closer and closer to zero. This ESR is in series with the tester's charging resistor, causing the time constant to increase and the apparent value to increase.

The higher readings do not cause testing problems, however, because of the wide tolerance placed on electrolytics. A typical electrolytic specification is -20%, +100%, meaning a capacitor marked 50 μ F could have a value anywhere between 25 μ F and 100 μ F and still be within the manufacturer's tolerance. The variations between readings never vary between test methods by more than the marked tolerances for a good capacitor.

The biggest problem with an R-C tester, however, is that many capacitor failures do not cause the value of the capacitor to change. Therefore, a value-only tester often will indicate a good capacitor when it actually causes problems in the circuit. Better testers have more tests (such as leakage at rated voltage, ESR and dielectric absorption) to find capacitor prob-

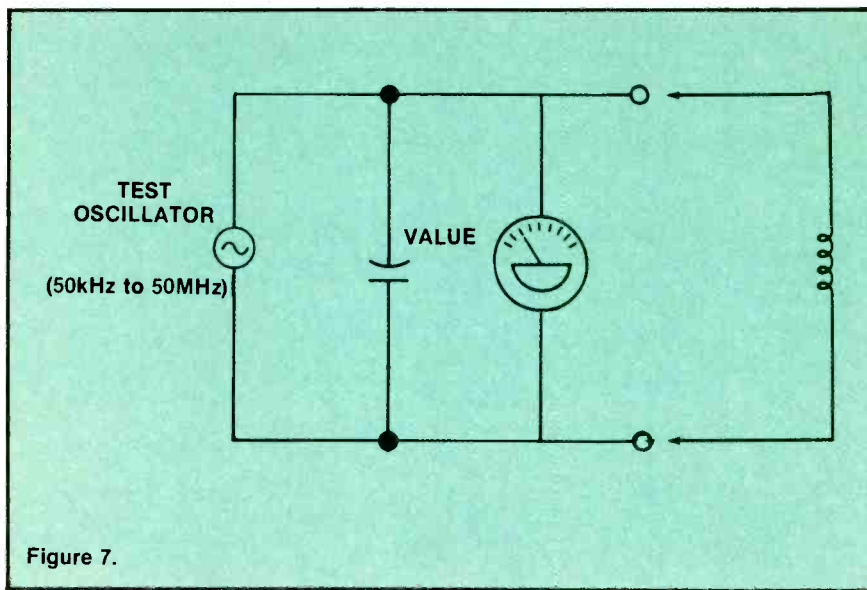

Figure 7.

Figure 7. The Q meter measures the voltage across the L/C tank circuit to indicate when it reaches resonance with the test oscillator frequency.

lems missed by the R-C value test alone.

Q meter

The Q meter is mainly used for testing coils used in high frequency circuits. The main advantage, compared to an impedance bridge, is that it uses much higher test frequencies, so that the value and the Q indications will be closer to the way the inductor responds in the circuit than when tested at 120Hz or 1,000Hz. The Q meter does not, however, work at frequencies much below 50kHz, meaning it has limited uses on coils with low self-resonant frequencies, such as chokes.

The Q meter consists of an adjustable oscillator, an ac voltmeter, and a low-loss tuning capacitor. The operator adjusts the oscillator frequency and the tuning capacitance for the highest meter reading. This indicates that the unknown coil and the internal capacitor are in resonance with the selected frequency.

Unlike with a bridge, however, it is unnecessary to alternate between the two adjustments to find a single null point. In fact, there is no single combination of adjustments that applies to a particular coil. One of the two adjustments is preset, and the second one then tuned for the highest reading.

Generally, the frequency is set to

one of six frequencies, depending on the value of the coil. The tuning capacitor is then adjusted for peak reading and the inductance value is read from the capacitor's dial.

Although the Q meter tests the coil under conditions that are much closer to the way the coil responds in the circuit, it usually does not duplicate the circuit completely, unless the circuit happens to operate at one of the six predetermined test frequencies. The oscillator can be set to test the coil at a particular frequency, but the inductance values marked on the tuning capacitor will no longer apply. Formulas can be used to approximate the actual value at other frequencies.

DI/DT inductance testing

This inductor testing method is similar to the R-C capacitor testing method. It depends on the basic definition of inductance,

$$E(t) = L \, di(t)/dt,$$

which does not involve phase angles nor frequency components. This formula is based on a coil's property to produce a reverse voltage (EMF), which depends on the inductance (L) and the *rate of change* of the current passing through the coil, $di(t)/dt$ in the formula. When the current reaches a steady-state condition (no longer changes), the only voltage across the coil will be caused by the dc coil resistance.

Take the Guesswork Out of VCR Service

Tentel now has 3 products for quickly and easily diagnosing the mechanical performance of VCR's. The Tentelometer®



tape tension gauge is the world standard for tape tension measurements to prevent skewing and interchange problems. The TSH gauge series finds problems causing edge damage and binding cassettes, the two biggest causes of tape destruction. The New HPG-1 head protrusion gauge represents a breakthrough for an accurate, easy to use method of determining head life; takes the guesswork out of video head replacement. The HPG-1 for Beta, VHS, and U-matic VCR's measures head tip protrusion and drum eccentricity in both microns and ten thousandths of an inch.

These 3 products allow the entire mechanical performance of a VCR to be measured in a few minutes by only removing the top cover of the VCR.

Call or write for details—We want to help.

TENTEL

(408) 379-1881

1506 Dell Avenue

800/538-8894

Campbell CA 95008 Telex 910 590 8001

Circle (18) on Reply Card

ATTENTION TECHNICIANS

- ★ JOB OPENINGS
- ★ MONTHLY TECHNICAL TRAINING PROGRAM
- ★ BUSINESS MANAGEMENT TRAINING
- ★ LOW COST INSURANCE
- ★ CERTIFICATION
- ★ TECHNICAL SEMINARS

All of this in a nonprofit international association for technicians

FIND OUT MORE:



604 N. Jackson St.
Greencastle, IN 46135

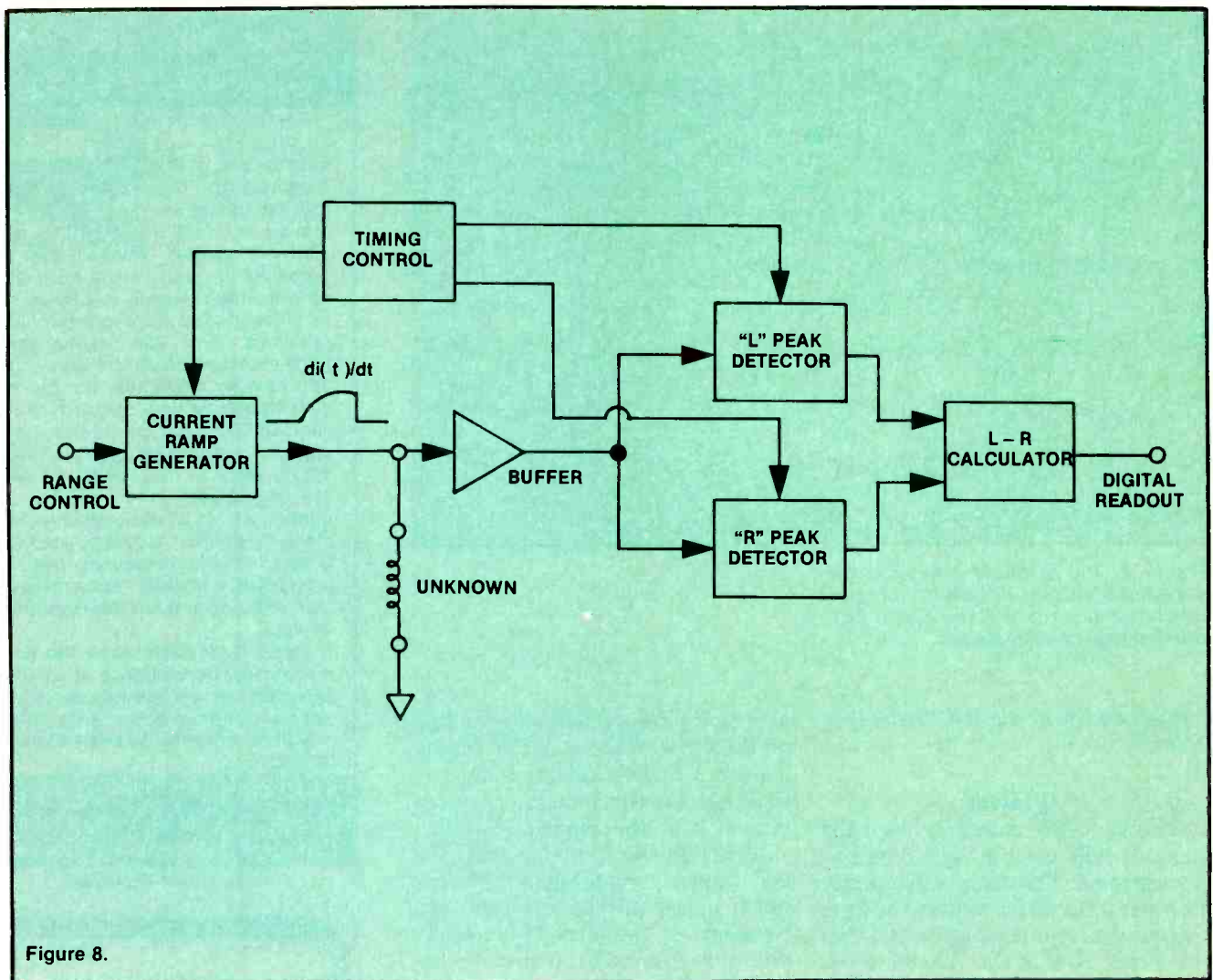

Figure 8.

Figure 8. The di/dt inductance test measures the reverse EMF generated during the climbing current ramp and then subtracts the voltage drop from the resistive value during the steady current level.

As Figure 8 shows, the DI/DT test applies a current ramp through the coil, while a peak-detector stores the highest induced voltage on a capacitor. After reaching its peak, the current generator then holds the current at a constant level for several milliseconds to determine the dc resistance of the inductor. The resulting steady-state voltage is then subtracted from the peak value stored on the capacitor to determine the true inductance.

The DI/DT method effectively tests the coil at a frequency as close to zero as possible. (Inductance cannot be tested with pure dc because it only has dc resistance without a changing signal.) Similar to the R-C capacitance tests, the DI/DT inductance test provides a way to determine inductance value much easier than with an impedance bridge and with lower cost than the quadrature phase detection method. It reads the same value as all the other induc-

tance test methods on low-loss (high Q) coils.

Sencore Z Meters use this patented method to determine inductance, the patent on this test method explaining why it is not found on other testers. These units also include a special *ringing* test that detects shorted turns in most inductors without needing to know the value of L or Q. The ringing test measures the effective Q, but the readings are scaled, so good inductors display a value larger than 10 and bad ones show a value less than 10. In this way, the actual Q value does not need to be known.

As we have seen, there are many methods to test reactive components. Each has some advantages and some disadvantages, depending on your particular testing needs. The best way to choose a tester is to decide what types of tests you will need and then locate the tester that gives you these tests at a reasonable cost.

ES&T

Books

Editor's note: Periodically *Electronic Servicing & Technology* features books dealing with subjects of interest to our readers. Please direct inquiries and orders to the publisher at the address given, rather than to us.

Reference Data for Engineers: Radio, Electronics, Computer and Communications—7th edition, Edward C. Jordan, editor-in-chief; Howard W. Sams, a division of Macmillan, Inc.; 1,368 pages; \$69.95, hardbound.

Here is an updated, revised and expanded "engineer's bible," as previous editions of this reference book have been designated. Changes, which include the latest facets of state-of-the-art technology, reflect the dramatic expansion of the entire field of electronics

since the last edition was published. There are 48 detailed chapters covering subjects such as integrated circuits, optical communications, analog and digital communications, computer communications networks, satellite and space communications, computer organization and programming, digital signal processing and acoustic wave devices,

Published by Howard W. Sams, 4300 W. 62nd St., Indianapolis, IN 46268.

Computer User's Guide to Electronics, by Art Margolis; Tab Books; 336 pages; \$15.45 paperback, \$24.95, hardbound.

Readers are shown how to analyze the symptoms of a distressed computer, make quick checks, perform maintenance tasks, do logic probe tests and change chips without fear by this author, who is an experienced technician. Art Margolis uncovers the mystery surrounding analog and digital circuitry. In layman's language, and with detailed illustrations, the electronics used in computers is reduced to these essentials: the 13 functions that

make up the core of computing; the interface circuits that communicate signals between digital and analog; how the MPU communicates with the memory map; how to read manufacturers' spec sheets for the chips; the safe way to diagnose and repair a computer.

Published by Tab Books Inc., Blue Ridge Summit, PA 17214.

An Introduction to Circuits and Electronics, by J.R. Cogdell; Prentice-Hall; 384 pages; \$39.95, hardbound.

The author intends this book to be an intro to electrical engineering, but acknowledges that there will be many non-engineer, technically directed readers who will benefit from his presentation of electrical and electronics basics. Half of the book is devoted to electric circuit theory because practically every electrical device is a circuit of varying degrees of sophistication. Also, circuit theory has generated the language of electrical engineering. In the second half of the book, Cogdell introduces the reader to electronics,

Published by Prentice-Hall, Englewood Cliffs, NJ 07632.

SPRING SALE \$		\$ SPRING SALE	
Popular	Min. Spcs. P/Type	Min. Spcs. P/Type	Min. Spcs. P/Type
Flybacks & Triplers	AN-214 0.88	LA-4460 1.25	
FO-1123	11.00 AN-240 0.75	LA-4461 1.10	
FB-1108	11.00 CX-143 4.50	MB-3712 0.95	
4-2751-48500	7.50 CX-186 3.00	MB-3713 1.10	
4-2751-48600	7.50 HA-1377 1.30	TA-7205 0.57	
Z-0040	9.50 HA-1388 1.50	UPC-1181 0.45	
Z-0064	9.50 HA-1398 1.70	UPC-1182 0.45	
		UPC-1185 1.40	
Min. Spcs. P/Type	Min. Spcs. P/Type	Min. Spcs. P/Type	Min. Spcs. P/Type
STK-437	3.30 2N-3055 0.50	2SD-355	0.20
STK-2129	4.80 2SA-634 0.29	2SD-600	0.25
STK-3042	3.08 2SA-473 0.25	2SD-613	0.40
STK-3082II	2.75 2SC-1172 1.55	CX-187	3.90
STK-4141II	5.90 2SC-1384 0.20	CX-188	2.60
STK-4362	3.00 2SC-1413 1.55	IN-4007	0.07
STK-7216	1.40 2SC-1318 0.09	IN-4148	0.04
STK-8250II	9.00 2SC-1675 0.08		
Matching Transformer	Min. 100pcs		0.19
2 Way Splitter	Min. 20pcs.		0.39
F Type Female Splice	Min. 100pcs.		0.11
Deluxe Desoldering Gun			1.85
Video Cassette Rewinder			11.00
UHF/VHF/FM Dist. Amplifier			9.50
Car Antenna (Honda) Min. 3pcs.			1.00
Top of Line Wire/Wireless Microphone			10.40

* Call or write for our current flyer
 * Quantity prices available
 * C.O.D. orders welcome (Min. Order \$25.00)

PRICE SUBJECT TO CHANGE WITHOUT NOTICE. OFFER GOOD WHILE SUPPLIES LAST.

NIPPON AMERICA, INC
 call 9600 n.w. 12 st. miami fl 33172
 toll free 800-327-7522
 305-592-2616

Circle (15) on Reply Card

COMPACT ECONOMICAL DESOLDERING

It's so Dependable, there's a Two-Year Warranty on the Pump. The EX-525 may be A.P.E.'s lowest-cost portable solder extractor, but it's full of features: • easily desolders components from multi-layer PC boards • pump is vibration-isolated for quiet operation • Model 550 for use with shop air • EX-1000 handpiece is non-clogging and temperature-regulated by panel controls.

You need the A.P.E. EX-525 in your shop. Call or write today for all the details. **Automated Production Equipment Corp.**, 142 Peconic Ave., Medford, N.Y. 11763 • 516-654-1197, TWX: 510-228-2120

DEPEND ON A.P.E.

Circle (16) on Reply Card

What do you know about electronics?

By Sam Wilson

Visual modulation

Unless you are a specialist in communications, you may not have spent much time trying to visualize the various types of modulated signals. However, this is an important part of understanding modulation and other complex waveforms. It is especially important today when these complex waveforms are being converted into digital equivalents for the new all-digital audio and TV systems.

In this article I want to lay some of the groundwork that will give a better understanding of some modulated waveforms.

Figure 1. This representation gives a picture of how the amplitude, time and frequency are related in a waveform.

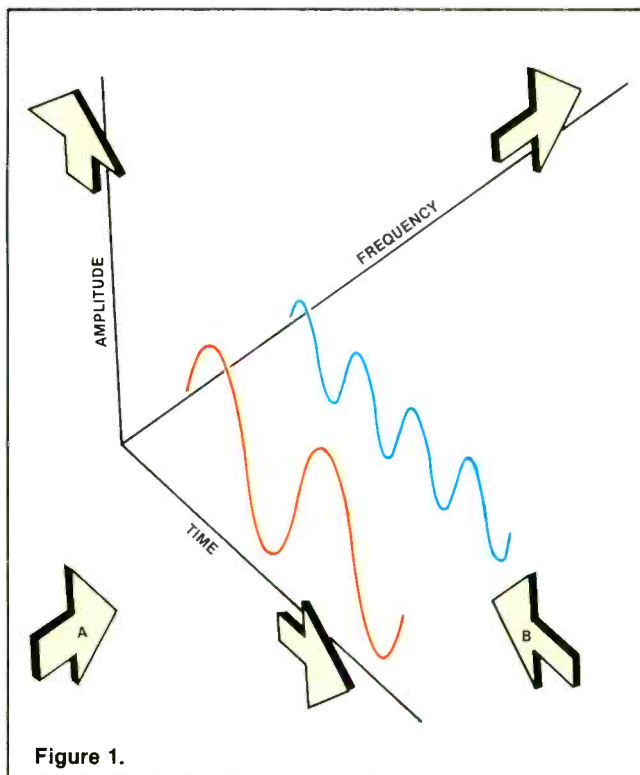

Oscilloscope displays

The oscilloscope is the best instrument to use for visualizing waveforms. Unfortunately, it provides a 2-dimensional display of a 3-dimensional waveform, so, we have to imagine our position for the third dimension.

There are three facets of a waveform: *amplitude, frequency and time.*

Figure 1 is a 3-dimensional drawing that shows how the three facets are related. Figure 2 shows how the waves look on a time domain display (viewed from A of Figure 1) and a frequency domain display (viewed from B of Figure 1.)

Time domain displays are used when it is necessary to view the shape of a waveform. That is the

usual oscilloscope display and it will not be discussed further in this article.

The *frequency domain display* is useful for showing the relationships between frequencies.

Another type called the *logic domain* displays the zeros and ones for various points in a logic circuit. It will not be discussed here.

There hasn't been much success with 3-dimensional displays, but I remember one very clever version.

Figure 2. Looked at in the direction of arrow A in Figure 1 (the time domain), the amplitude-time-frequency plot would look like the one shown in A. Looked at in the direction of arrow B in Figure 1 (the frequency domain), the amplitude-time-frequency plot would look like the one in B.

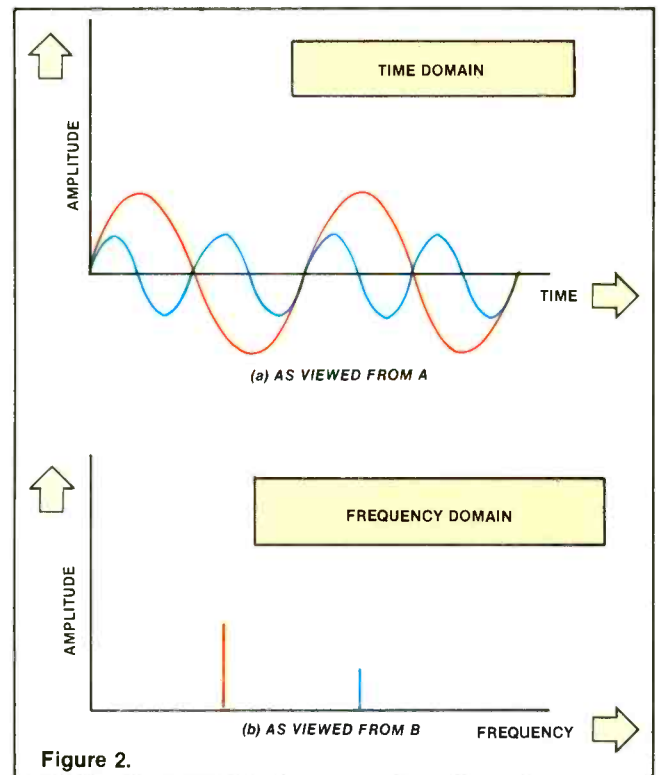

It was used to track the path of missiles that were fired down the Atlantic range.

The scope was made in an aquarium filled with a plain gelatin. The bottom of the aquarium was a relief map of the eastern seacoast of North and South America.

When the missile fired, its route was traced with the end of a fine (long) hollow needle. India ink was emitted from the end of the needle, and the ink was trapped by the gelatin.

As the missile moved, the ink from the pen left a permanent path that showed the down-range trajectory.

You can accomplish the same thing today with a personal computer graphic display. We have come a long way in the 30-plus years since the gel scope.

Figure 3 shows the frequency domain display of a signal that is amplitude modulated. A time domain display of the AM signal also is shown in this illustration.

In the frequency domain display, the carrier is a single frequency seen from the end view. There is an infinite number of frequencies set edge to edge in each sideband display. This display shows that over a period of time all of the audio modulating frequencies would eventually be present.

The two displays of Figure 3 demonstrate the problem of oscilloscope 2-dimensional displays. You can't see the sidebands in the time domain display, and you can't see the wave shape in the frequency domain display. In other words, it takes two displays to show the signal accurately.

In order to perform a sweep alignment, it is necessary to use the oscilloscope in the frequency domain display. Figure 4 illustrates this concept.

The familiar test setup is shown in Figure 4(a). The sweep generator moves the scope trace horizontally along the line that is marked "frequency" in Figure 1. The amplitude at every point is based on the frequency response of the turned circuit under test.

The overall result, shown in Figure 4(b), is an infinite number of frequencies seen on edge. A marker on the response curve is used to indicate some particular frequency on the response curve.

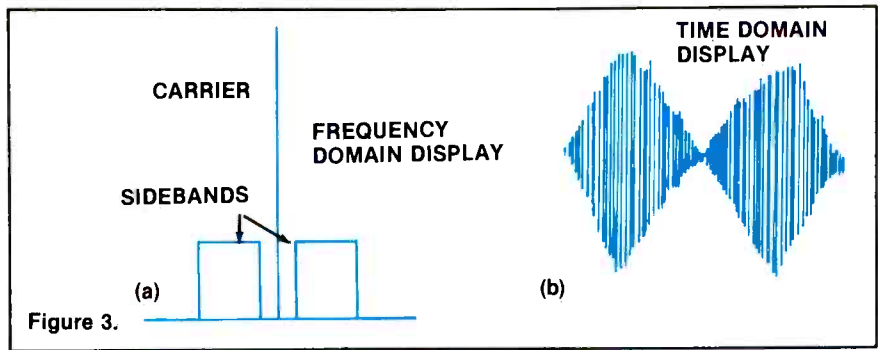

Figure 3. An amplitude-modulated signal would appear as the drawing of A in the frequency domain and as the drawing B in the time domain.

I have never been able to understand the reluctance of technicians to use the Z-axis of an oscilloscope for adding the markers to the display. The Z-axis controls the display brightness.

When the marker signal, which is a fixed frequency, is delivered to the Z-axis, there is a bright spot on the display that represents the marked point.

The advantage of using this method for marking is that there is little likelihood of the marker interfering with the sweep display.

The marker also can be added between the tuned circuit and scope. This point is marked with an "x" in Figure 4(a). That is sometimes called the *post marker* method.

Markers should *never* be in-

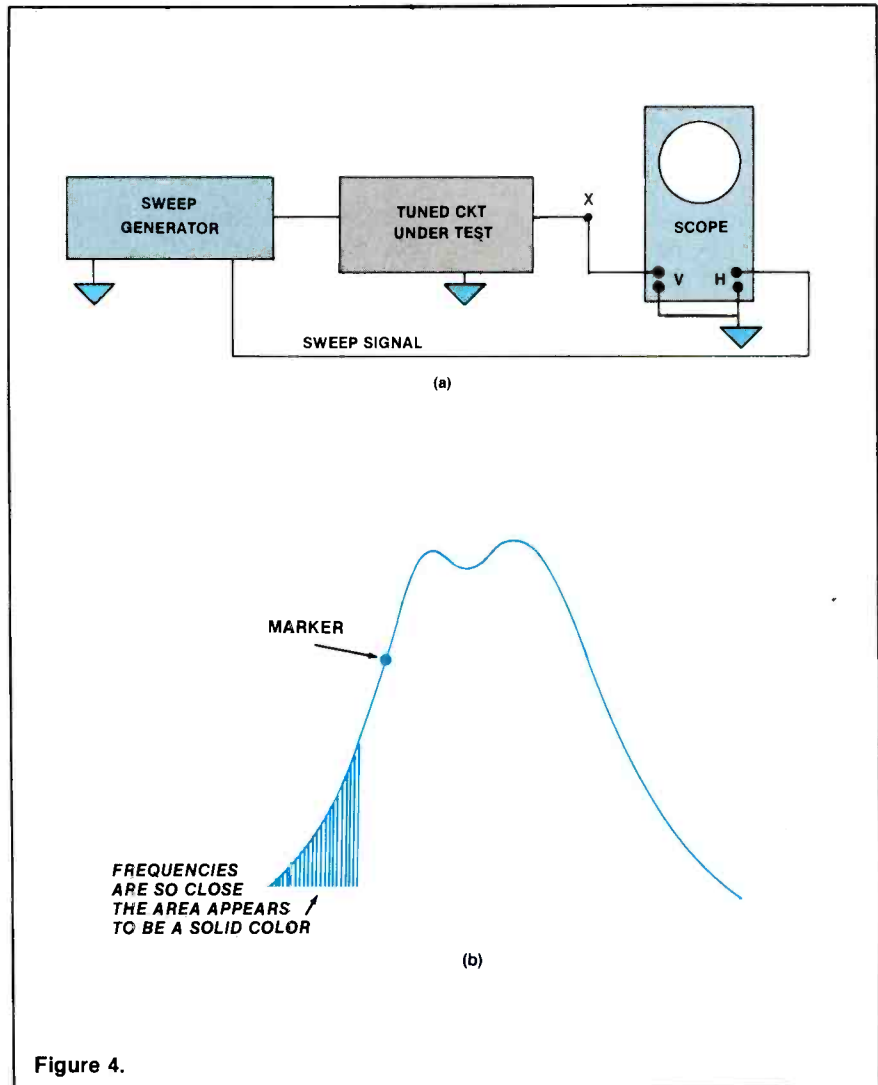

Figure 4. Sweep alignment is carried out using a setup such as this.

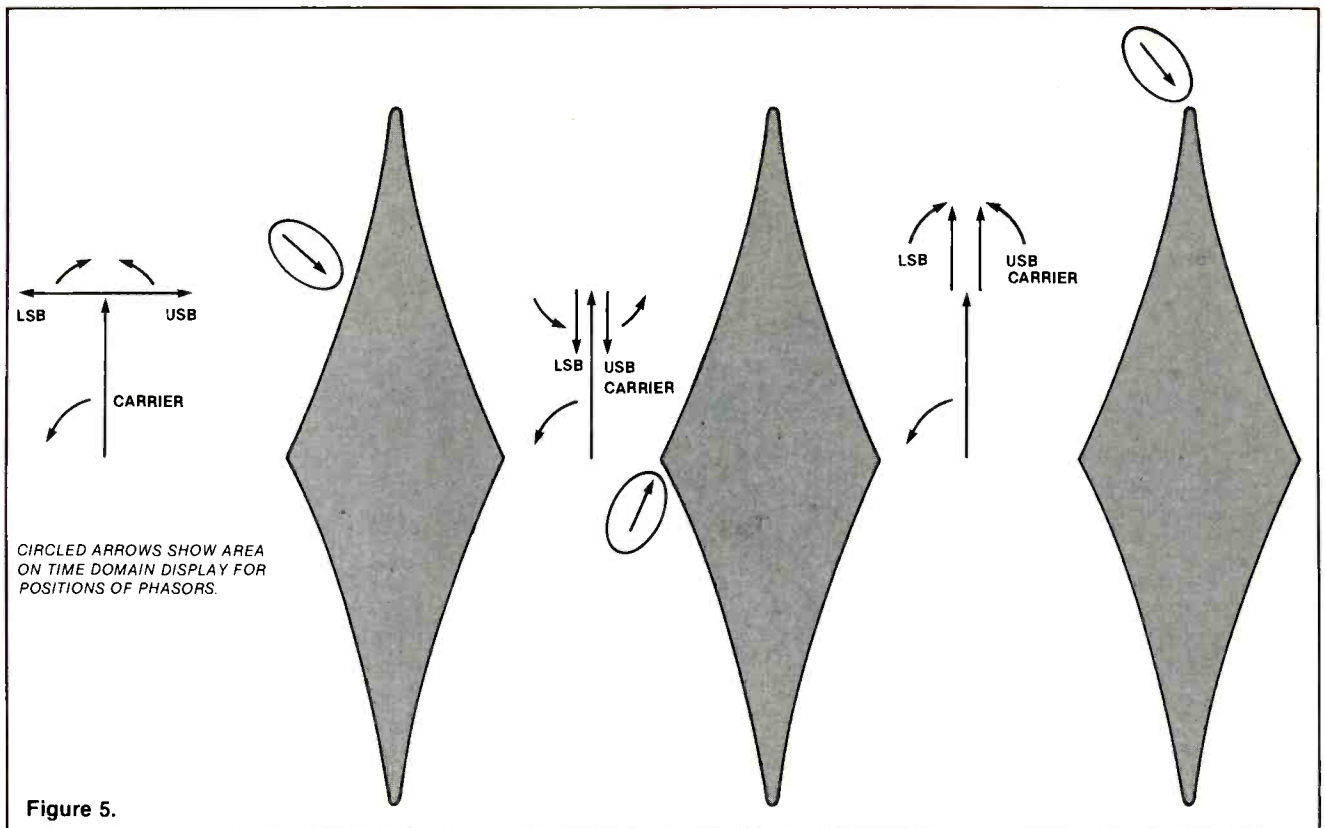

Figure 5.

Figure 5. Another way to visualize waveforms is to use rotating phasors.

sented at the point marked "y" because that is almost sure to produce distortion of the display. This is true although the amplitude of the marker is set per manufacturer's recommendations.

Before there was sweeping there was wobbling

When someone finally gets around to making a trivia game for technicians, the term *wobbulator* is sure to be included. That is the name of early (1930s and 1940s) sweep generators used for aligning the IF stages of superheterodyne radios. It was a signal generator with an L-C tuned circuit. One plate of the capacitor was mechanically jiggled to cause the frequency to sweep.

Phasor representation

Another way to visualize waveforms is to use rotating phasors. As with the oscilloscope displays, all waveforms can be represented this way. However, it does require a considerable amount of imagination. Take the case of a rotating phasor used to produce a 100% modulated AM signal. (This waveform is shown in Figure 3.)

Figure 5 shows how the rotating

phasors produce the AM signal.

The AM signal is produced by three individually rotating phasors. The long one represents the carrier. The audio modulating signal produces sidebands that are represented by smaller phasors rotating in opposite directions.

To get any point on the amplitude-modulated signal you simply take the resultant of the three phasors. If you are trying to visualize the rotating phasors, you must make the carrier phasor rotate at the AM frequency—say 1MHz. The sideband carriers rotating in opposite directions must turn at a rate that is one-thousandth the speed of the carrier phasor.

In other words, for a 1,000Hz modulating signal on a 1MHz carrier, the carrier phasor rotates a thousand times each time the sideband phasors rotate one complete circle.

You can see from this visualization that the illustration in Figure 3 is not accurate. To make it accurate, you would have to draw 1,000 carrier waveforms in the space of one audio cycle on the signal envelope.

When you are visualizing the rotating phasors, it is convenient

to start by picking the place where the modulated signal has zero amplitude and also where the amplitude is twice the average amplitude. When the sideband phasors are pointing against the carrier phasor, they add together to equal the carrier and the amplitude is zero. This is shown in Figure 5.

When the sideband carriers are both pointing in the same direction as the carrier, they add together to produce a resultant that is twice the carrier length.

At all other points, the sideband phasors combine to produce the resultant wave shape.

It takes a very healthy mind to be able to visualize a simple amplitude-modulated wave in this manner. In a single sideband signal, you eliminate the carrier phasor and one sideband phasor and then visualize the remaining phasor as it moves around in its orbit. The projection of that phasor on a time axis represents a single sideband signal. That takes an even healthier mind.

Nevertheless, many technicians visualize complex modulated waveforms in this manner. If you aren't already doing so, you should at least give it a try.

ES&T

Photofact

These Photofact folders for TV receivers have been released by Howard W. Sams since the last report in ES&T.

AOC C3621RA, C3622RA (RUN 10A)	2397-1	RCA Chassis CTC117C	2402-2
EMERSON ECR-215	2398-1	SEARS 562.41520450/451	2400-2
EMERSON EC-133A	2399-1	WARDS GNB12884A/B/C	2403-2
GENERAL ELECTRIC Chassis 19PC-F, 19PC-H	2399-2	ZENITH A1908W6/20W1/20W3/22PT1/26W4/36P4/92W1, SA1923W1/23X1/27W4/37P4/97W4, SV3921W1	2397-2
KTV KCT-5003	2400-1	ZENITH A1908W5/20W5/20W6/26W/36P/92W5/92W60/96W, S1906C5/C60, SA1923W5/W60/X5, SA1927W/37P	2401-2
PHILCO R3939WWA01, R3939TWA01	2402-1	COLOR MONITOR SANYO AVM255	2401-1
QUASAR Chassis GC110, MC110	2398-2		
QUASAR Chassis ABDC119, ALDC119, BDC119, GC119	2403-1		

NESDA Computer Group

COMPUTER SALES AND SERVICE DEALERS
WORKING TOGETHER

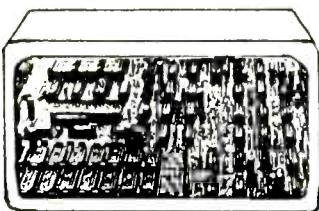

NESDA

- Service training.
- Assistance in selecting in-house equipment and software.
- Specialized software for service management.

- Factory contacts for service literature and parts.
- Involvement in a stable and productive national trade association.

FOR MORE INFORMATION SEND BUSINESS CARD TO:
NESDA COMPUTER GROUP, 2708 WEST BERRY STREET
FORT WORTH, TEXAS 76109; PHONE (817) 921-9061

OPTIMA ELECTRONICS

2022 Tigertail Blvd.

Dania, Florida 33004

In Florida Call: (305) 920-3550 Nationwide Call: 1-800-327-0224

TO ORDER CALL TOLL FREE 1-800-327-0224

Call and ask for our current flyer

- 2SC1172B Toshiba \$1.69 ea. min. 50
- 2SC2315 - REP. ECG 152 \$.29 ea. min. 50
- 2N3055 - REP. ECG 130 \$.45 ea. min. 20
- TDA2002V - REP. ECG 1232 \$.50 ea. min. 10
- PN2222A - REP. ECG 123AP \$.06 ea. min. 500
- AN239 \$6.99 ea. min. 5
- 523/526 - tripler \$10.95 ea. min. 10
- 4.7 mfd @ 50V radial \$.10 ea. min. 100
- .01 mfd @ 100V ceramic disc \$.06 ea. min. 100
- 6GH8 - G.E. brand \$2.04 ea. min. 10
- 8950 - G.E. brand \$12.95 ea. min. 3
- 6MJ6/6JE6/6LQ6 - Sylvania brand \$8.95 ea. min. 5
- 2-way splitters (UHF/VHF) \$.59 ea. min. 25
- F59/F59A - cable connectors \$.09 ea. min. 200
- TV/VCR push-on quick connect balun \$.60 ea. min. 10
- Rembrandt Power King 900
(top of the set) \$8.95 ea. min. 6
- Back of the set antenna \$2.40 ea. min. 5

Terms of Payment & Shipping:

1. \$75.00 minimum on all orders!
2. Orders will be sent by COD, Visa or Master Card!
3. COD on new accounts must be certified check or cash!
4. All merchandise has a (6) six month warranty unless stated otherwise!
5. All orders shipped via UPS or U.S. Post Office within 24 hours!
6. Prices subject to change without prior notice!
7. Offer good while supplies last!

Ask for our free flyer!

SEND CHECK OR MONEY ORDER TO:

OPTIMA ELECTRONICS

2022 Tigertail Blvd., Dania, FL 33004

Phone (305) 920-3550 TOLL FREE: 1-800-327-0224

Circle (17) on Reply Card

Products

Circuit repair kit

APE Corporation announces the addition of the Combat Circuit Repair Kit to its line of PCB repair/rework systems. Included in the kit are systems for replacing circuits, plated-through holes and laminates. Also included is a variety of circuit saws and fixtures as



well as all necessary tools, fixtures and materials to repair virtually any kind of PCB damage.

Circle (75) on Reply Card

Multifunction capabilities

The Electra, AEMC's multifunction meter, measures current, voltage, insulation resistance and ground conduction continuity. When used with an optional light



module (model CL2010), the Electra measures light intensity. When used with an optional ground resistance tester module (model CRT2010), it becomes a ground resistance tester. The Electra features a large, 2,000-count LCD

display, as well as built-in safety features such as a warning beeper that indicates unwanted ac on continuity and insulation tests, and a permanent overload protection up to 600V on all ranges without damage. It also can be used with all of AEMC's Add-a-Function modules (each of which can transform the Electra into a dedicated instrument capable of measuring many different parameters).

Circle (76) on Reply Card

Variable sensitivity control

Riser-Bond Instruments has introduced an improved digital time domain reflectometer, cable fault locator, with a new, adjustable sensitivity control.

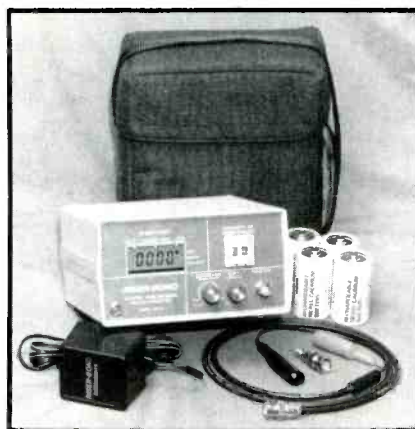

The model 2901B with variable sensitivity is adjustable from at least 20dBRL to 40dBRL. This feature of the model 2901B will afford greater flexibility, enabling the user to find smaller problems, measure longer cables, and look through some multiple faults.

Circle (77) on Reply Card

Continuity tester

Vaco Products offers the No. 70305 continuity tester that detects shorts or broken circuits in all types of electrical devices.



Used for testing circuits with power off, the 70305 checks lamp cords and fuses, motors, electrical

appliances, switches and receptacles, and many other devices. It features a 36-inch lead wire with a fully insulated alligator clip, and a 3¼-inch pointed probe. The exclusive Comfordome handle has a nylon cap that can be removed for battery and bulb replacement.

Circle (78) on Reply Card

Cable fault locator

Model 6500 cable fault locator, by Triplet (a Penril Company) provides direct readout of cable

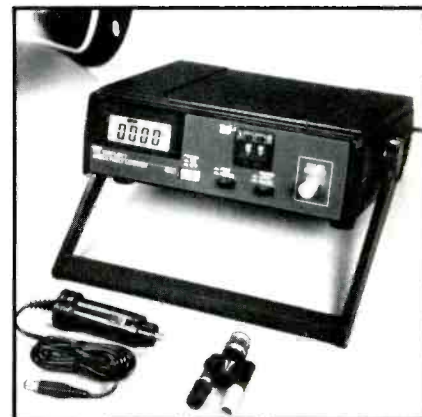

length, detects and identifies location within one foot of shorts or opens on a variety of cable types from 15 to 6,000 feet in length. It is capable of making measurements on coax cables, twisted pairs and on power cable used for indoor wiring, cabtyre cable and multiconductor shielded cable. An NVP reference chart is included with each unit.

Circle (79) on Reply Card

Up to four extra hands

Few jobs in the electronic and electrical world are more frustrating than the ones that require "three or more hands"—two to hold the work and a third or more to apply solder or some other operation. The smaller the components, the more difficult it usually proves to position it accurately and firmly.

The Gripmate, from Gripmate Enterprises, is a clamp that provides up to four extra hands, able to grip small components, wiring and other items in an infinite number of positions.

A base block that clamps to a bench, cabinet or apparatus in any plane, carries four semi-rigid insulated wires (stayput arms), each fitted with an alligator clip to hold the job. Alternatively, any of the arms can be replaced with one at-

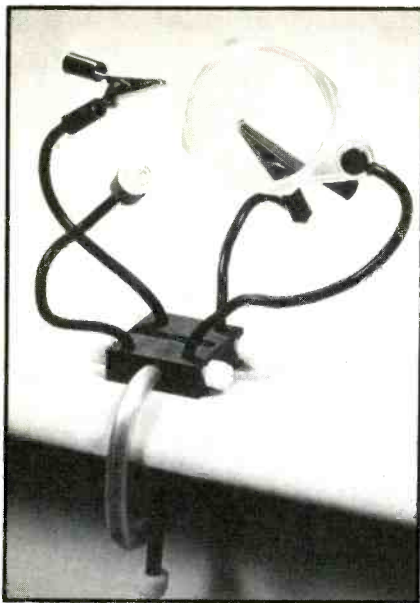

tached to a 48mm diameter 2.5x safety magnifying glass for close-up work, or a small magnet when this is more appropriate than the clip.

Circle (80) on Reply Card

Circuit cooler

A compressed-air-operated circuit cooler developed by *Vortec* eliminates the ongoing cost of canned freon for temperature cy-

cling tests of boards and components.

Model 138 circuit tester uses standard 80psi to 100psi shop or instrument air to produce a stream of 0°F to 10°F air capable of chilling boards or individual circuits.

The circuit tester contains a

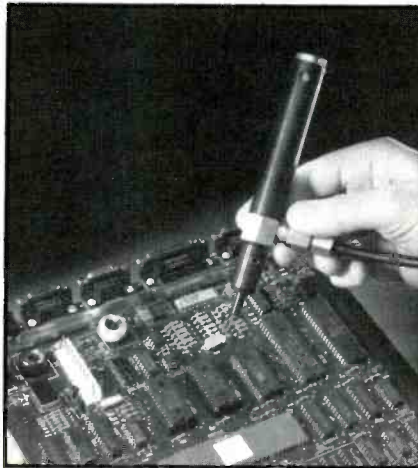

Vortex tube that creates two airstreams, one hot and one cold, from the ambient-temperature supply air. The low-cfm cold airstream is discharged through a nozzle at the working end, while the warm air is discharged radially

through a muffler. There are no moving parts to wear out or maintain, and the discharge air is totally free of contaminants. The device is lightweight, compact and well-balanced. It weighs 3.5 ounces, is about the size of a felt-tip marker and comes complete with a filter-separator/pressure regulator and 6 foot length of air line.

Circle (81) on Reply Card

Analog clamp-on multimeters

The instrumentation products division of *Beckman Industrial* is introducing two analog clamp-on multimeters, the CP60 and CP61, that provide a horizontal scale

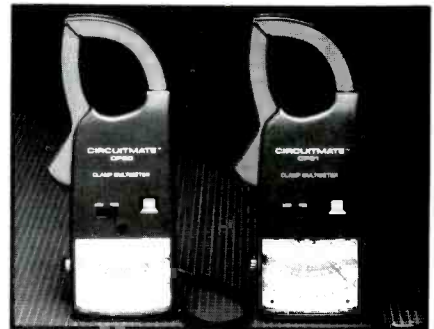

analog readout to accurately measure up to 600Aac, 600Vac,

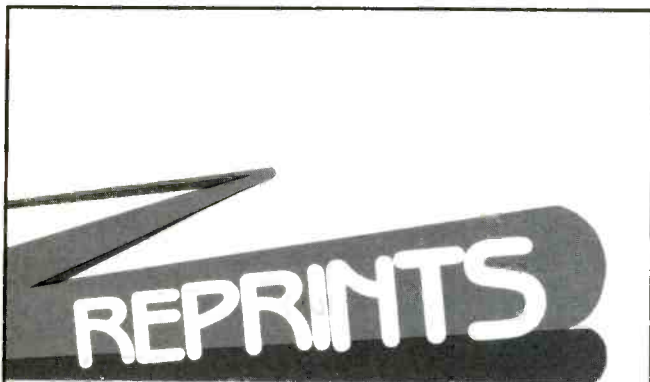

Interested in ordering article reprints out of this or another issue? * Reprints can be excellent learning tools for your technical staff and great marketing tools for your sales staff. Call or write Kelly Hawthorne at Intertec Publishing Corp., P.O. Box 12901, Overland Park, KS 66212; (913) 888-4664.

*Minimum order 1,000 copies

EVERYBODY'S A WINNER!

At the National Professional Electronics Convention



Informative Speakers
Management Seminars
Technical Training
Sponsored Meals
Tennis / Golf Tournaments

Sponsored by the National Electronics Sales & Service Dealers Association & the International Society of Certified Electronics Technicians

LAS VEGAS . TROPICANA . AUG. 4-9

Send for more information and an application to
NPEC, 2708 W. Berry St., Ft. Worth, TX 76109; Ph (817) 921-9061

Name _____

Address _____

City _____ State _____ Zip _____

and resistance in two ranges to 100kΩ. The basic accuracy of both meters is 3% of full scale.

Both the CP60 and CP61 incorporate a taut-band meter movement, and feature a pointer lock switch to protect the movement during storage, or to freeze a reading in the display. Both meters come equipped with semi-pointed jaws that facilitate capturing a single conductor up to 1³/₈ inches in diameter out of a bundle.

Circle (82) on Reply Card

Scope-DVM interface

From *Creative Electronics* comes the scope-DVM interface (SDI), which is interposed between an X10 scope probe and the scope.

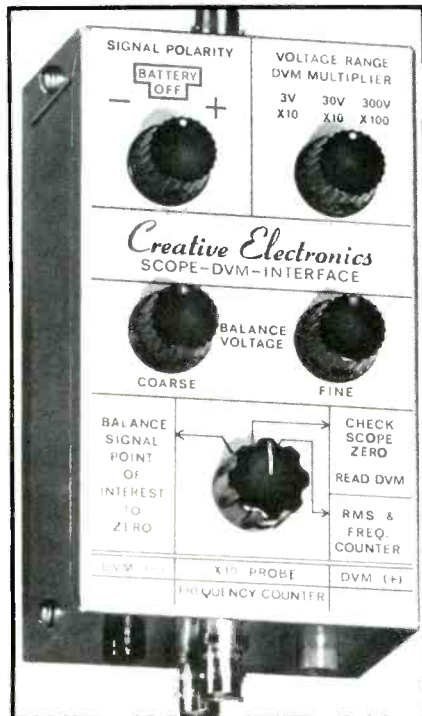

The SDI outputs a dc voltage to the DVM that is equal to the instantaneous value of the signal point of interest selected by the operator. The signal point is selected by moving the waveform with coarse and fine controls until the signal point is coincident with the zero base line.

There is an extra BNC output for frequency counter or distortion meter. Use just one x10 probe.

Circle (83) on Reply Card

Dynamic component analyzer

Merc-O-Tronics Instruments has developed the model 85 on-board dynamic component analyzer. With this analyzer, the condition

of hybrid semiconductors, microprocessors, OP-amps, A-D converters, CMOS, TTL, voltage regulators, transistors, diodes, capacitors and resistors is dynamically evaluated and visually displayed on an oscilloscope. This



Circle (84) on Reply Card

Digital multimeter

The TIF200 3¹/₂-inch digital readout multimeter is being added to TIF's product group.

According to the manufacturer, this pocket-sized multimeter is capable of accurately providing 26 popular ranges as needed in a unit of its kind.

Additionally, the TIF200 incorporates features such as instantaneous upgrade, gold switch contacts, overload protection and low-battery indication.

Circle (85) on Reply Card

Autoranging digital capacitance meter

MC 300 is a battery-powered, completely autoranging capacitance meter presented by *Pilot Marketing*. This unit also identifies transistors (NPN, PNP), their leads (E, B, C), tests zener diodes and rectifiers up to 24V and calculates cable length.

There is a full 4-digit, 0.5-inch LCD display autoranging with 10-range manual capability. Ten capacitance ranges from 000.1pF to 999.9mF, true capacitance, leakage, time constant, dielectric absorption, zeroing and sorting and other features. The hold function freezes display values during seven test modes. There are diode clamping and fuse-protected inputs at both input sockets and banana jacks.

Circle (86) on Reply Card

ES&T

Answers to the Quiz

By Sam Wilson

Questions are on page 23

1. C—See "Diagnosing and Correcting Shutdown Problem" (by Homer L. Davidson) in the December 1985 issue.

2. D—See "What Do You Know About Electronics?" (by Sam Wilson) in the December 1985 issue.

3. D—See "What Do You Know About Electronics?" (by Sam Wilson) in the December 1985 issue.

4. A—See "Repairing the Consumer Color Video Camera" (by Neil Heller) in the December 1985 issue.

5. B—See "LCD Rivals CRT" in the January 1986 issue.

6. B—See "Horizontal High-voltage...and Vertical Problems in the RCA CTC 109A" (by Homer L. Davidson) in the January 1986 issue.

7. A—See "Test Your Electronic Knowledge" (by Sam Wilson) in the January 1986 issue.

8. B.—See "An Important Notice" in the January 1986 issue.

9. D—See "What Do You Know About Electronics?" (by Sam Wilson) in the January 1986 issue.

10. B—See "News," page 28, in the November 1985 issue.

Readers' Exchange

For Sale: Communications service monitor, FM10C Singer Gertsch, calibrated by Communication Instruments. April 1984, 54kHz to 512MHz. Includes RF module, frequency indication monitor and oscilloscope deviation monitor. Will consider trade. **Wanted:** Microfiche reader. *The Electron Shop, 509-633-2620.*

For Sale: Sams Photofact folders Nos. 36 through 496 (some missing), \$1 each, or 321 total for \$250; Sams record changer service manuals, CM-2 through CM-9, RC-11 and RC-12, \$3 each, or all 10 for \$20; Philco wide-band oscilloscope amplifier, model 8300, good condition but no manual, \$15. All prices plus shipping. Call or send s.a.s.e. for complete list. *John Brouzakis, 247 Valley Circle, Charleroi, PA 15022, 412-483-3072.*

Needed: Schematic for Sharp TV model C931. Will pay for copy. *Ship and Shore Electronics, Box 203, Deale, MD 20751, 301-867-4006.*

Wanted: Schematic for Magnasonic TCT-1455 color television, or information concerning manufacturer's address. *Ray Hughes, 1156 Spruce St., Winnipeg, Manitoba, R3E 2V3, Canada.*

Wanted: Manuals for B&K 1450 diagnostic oscilloscope/vectoroscope, and 1240 color-bar generator. **For Sale:** Old test gear and TV parts, s.a.s.e. for list. *Jim Corliss, 2446 Vista Drive, Upland, CA 91786; 714-985-9967.*

For Sale: Talk-A-Phone intercom, 10-station master with five slaves, highest quality, \$200; RCA 7-band shortwave receiver clad in genuine top-grain cowhide, \$60. Both prices plus shipping, money order only. *N. Young, 214 E. Robertson St., Brandon, FL 33511.*

Needed: Jantzen electrostatic speaker parts and servicing information. *Ken Etherington, 509 E. 78th St., No. 5A, New York, NY 10021; 212-772-7334.*

For Sale: B&K 466 CRT restorer and analyzer with all manuals and setup charts, adapters included, excellent condition, \$100 includes shipping. *Gordon Lane, 239 Jacksonian Drive, Hermitage, TN 37076, 615-889-6195, no collect calls please.*

Needed: Information and/or service manuals model KTV, No. KCT 1950 19-inch table model color television, (120V, 60Hz, 90W), serial No. 91437799, manufactured June 1984. Chassis is KAC 1902, CRT is Samsung 5100 UX B22, serial No. 214 UX B22. Label on back gives manufacturer as Korea Electronics Co., Ltd., 189-2 Guro-Dong, Guro-Gu, Seoul, Korea (Made in Korea). Correspondence to this address was returned unopened. *W. Wilson Loveless, 3224 Albert Drive, Tallahassee, FL 32308.*

For Sale: Tektronix oscilloscope, 50MHz, dual trace with scope cart, model 467, complete with manuals, \$325; signal-strength meter by PTS, model mezzor, \$85. *M.B. Danish, P.O. Box 217, Aberdeen Proving Ground, MD 21005; 301-272-4984, after 6 p.m.*

Wanted: Sams Photofact folders from about 1500 to near-present. *Steven D. Ashcraft, 2916 Alvarado Square, Baltimore, MD 21234; 301-254-7119.*

For Sale: Heathkit IO-104 oscilloscope, \$200; B&K Precision 467 CRT restorer, \$200; B&K 1077 analyst, \$250; B&K 1246 color-bar generator, \$50; Telematic test jig, \$100. All in excellent condition. *B. Carter, 33578 Stonewood, Sterling Heights, MI 48077; 313-268-5963.*

Wanted: Schematic for Fisher AM-FM stereo radio and record player, Ambassador model A-690, serial No. 11506A. Will pay gladly. *G.K. Heldenbrand, 620 SE 4th St., Willmar, MN 56201.*

For Sale: Sams Photofact folders No. 31 to No. 1759, plus five 4-drawer, and six 1-drawer metal file cabinets for their storage. Best offer. *James P. Novak, P.O. Box 71, Smith River, CA 95567; 707-487-3743.*

Needed: For record player model No. 20- plus by KLR R and D, formerly of Canoga Park, CA (no forwarding address) - schematic, alignment procedure, copper bushing in the motor shaft, and the rubber wheel that turns the platter. *Andres Almanzar, 449 Torrey Ave., Bronx, NY 10473.*

For Sale: Sencore VA62 video analyzer/VC63 VCR test accessory/NT64 (NTSC) pattern generator (complete system) \$2500; Sencore SG165 AM-FM stereo analyzer test generator, \$450. Everything in mint condition. *Bob Goodman, CET, P.O. Box 452, Alexandria, LA 71301; 318-445-0262.*

Wanted: Sams Photofact folders 1400 to 1450, plus 1800-up; Sencore VA48. *C. French, Box 412, Ridgeland, MS 39158; 601-956-7878, anytime.*

Wanted: Sams Photofact folder No. 330, or Xerox copy of Sears 528-43750325. Will forward check immediately. *Robert Faeth, 6D Cardinal C.G.W., Lakehurst, NJ 08733.*

Wanted: Panasonic picture tube No. A26JAS31X; VCR tape-tension gauge, VCR service manuals. *Ed Herbert, 410 N. Third St., Minersville, PA 17954.*

For Sale: New SEALORD 6-channel SSB/AM marine radio by Southcom Military Comms. manufactures, \$550. Certified check or money order only. *N. Young, 214 E. Robertson St., Brandon, FL 33511.*

For Sale: Sencore VA48 with manuals, excellent condition, \$680; Sams Photofact folders complete from 900 to 1710 and 62 intermittent to 2264, \$1200 without file cabinets. *Robert E. Evans, 2318 Big Horn Ave., Cody, WY 82414; 307-587-5251.*

For Sale: 236 Sams Auto Radio manuals AR-19 (1963) through AR-254 (1978), \$1 each; Hickok tube tester model 6000 and adapter, \$100. *LeRoy Barnes, 118 W. Main St., Camden, TN 38320; 901-584-6411.*

For Sale: RCA 10J106B test jig and 50 adapters; B&K model 466 CRT tester, SD66 and 10 adapters; Sencore VA48; Castle Mark IV subber; EICO model 685 transistor analyzer; 700 tubes/caddy; Sams; EICO model 667 tube tester. Must sell. Best offers considered. *Richards Electronics, 192 Twelfth Ave., West Babylon, NY 11704; 516-884-4213.*

For Sale: Sencore SC61 waveform analyzer, \$2,200; Sencore CA55 capacitor analyzer, \$300; Hameg 3-inch test scope model HM307, \$300; Heath/Schlumberger model SP-2701, 60V, 1.5A power supply, \$125; Regency EC-175 frequency counter, 175MHz, \$100; Sencore VA62 video analyzer/VC63 VCR test accessory/NT64 (NTSC) pattern generator, complete system, \$2,500; Sencore CG22 Caddy Bar color generator, \$50; Heath SG-1271 function, audio generator, \$50. All equipment in mint condition. *Bob Goodman, CET, P.O. Box 452, Alexandria, LA 71301; 318-445-0262, 318-640-1466.*

For Sale: Rider's Radio manuals, vol. 1 through vol. 19; Rider's Television manuals, vol. 1 through vol. 8. Will not sell singly, will not ship, pick up only. Make offer. *Edmond F. O'Brien, CET, 323 E. First St., Clinton, NJ 07011; 201-772-0006.*

Needed: Used model MX6A pre-amplifier mixer, Bogen 1966,* high-impedance mikes-mixer, four inputs plus phone tuner; schematic for Coronado 45A86; audio output transformer, 25W to 30W Bogen No. T-279-1, impedance 4-8-15-70V line, new or used. *Lew Wollaston, Wollaston Radio & TV, 1504 Big Horn, Alliance, NE 68301; 308-762-3003.*

Wanted: 2-510JUB220 or MU19UJCP220 or 19UJCP22 picture tubes for 1979 Sears 564.42220701. In fair condition or repairable. Also 13JP22 for Admiral. Please send prices plus shipping. *Dan's TV, 316 East Ave. E, Hutchinson, KS 67501.*

For Sale: B&K 501A curve tracer, \$120; B&K 162 transistor/FET tester, \$100; Sencore AT218 attenuator TR219 transformer, FP201 and 39G89 probes, one-half price; 42 Sams Photofact folders, No. 600 to No. 800, \$50. Everything complete and in first-class condition. *Long's TV, 720 Goshen St., Salt Lake, Utah; 801-595-8442.*

Wanted: Service literature for Zenith models S1986W/S1986W6 (chassis 19KC54/19KC54Z) hospital model 19-inch color TV sets. Zenith manual SR-10, part No. 923-897. Will purchase or copy and return. *Frank's TV Service, 2909A Industrial Road, Las Vegas, NV 89109; 702-734-2248, 702-734-6203 (recording).*

For Sale: B&K 1077B, like new, with manual, \$250; Precision E-200C signal generator with manual, like new, \$75; EICO 147A signal tracer with manual, \$30. **Wanted:** Bird 43 thru-line wattmeter. No junk, please. *Bob Hogaboam, 1010 N. Tawus Lake Road, East Tawus, MI 48730.*

For Sale: RCA WT 110A automatic tube tester (uses punch cards, not chart), includes 500 prepunched cards, a master card to make additional cards, test card, set of punches and operating instructions, \$50 plus shipping (40 lbs.). No c.o.d., please. *C. England, 98 Montague, South Zanesville, OH 43701.*

For Sale: B&K 1250 NTSC generator, \$300; B&K 1803 frequency counter, \$90; B&K 820 capacitor tester, \$110. All like new. *Jess J. Peck, 958 Lowell Blvd., Denver, CO; 303-825-3912.*

For Sale: CB-13 and 2, AR-65, 69, 76, 104, 112, 115, 127, 140, 144, 146, 158, 176, 186, 241, 243, 276; MHF-48, 51, 53, 75, 77, 93, 96, 104, 127; TR-66 and 172; TSM-5, 6, 26, 28, 39, 52, 144, 157; Sams Photofact folders No. 1 to No. 1,000, \$600 for all, shipping not included. Will accept individual bids on CBs, ARs, MHFs, TRs, TSMs or Sams. Also 225 new tubes, make offer. *Triangle Electronics, 407 West Ave. N, San Angelo, TX 76901; 915-853-2211.*

Needed: Schematic diagram for the old Longines Symphonette. Please help! *Alexander Bell, 36 E. Levering Mill Road, Bala-Cynwyd, PA 19004.*

Chassis — Sylvania E32
PHOTOFACT — 2034-1

1

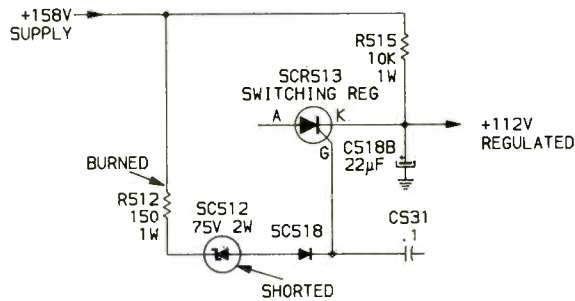

Symptom — Receiver dead, probably in shutdown
Cure — Check zener SC512 and replace if it is shorted. Also, replace R512 if burned by the overload.

Chassis — Sylvania E32
PHOTOFACT — 2034-1

2

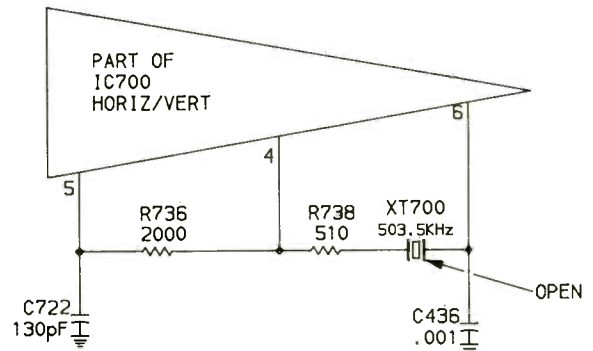

Symptom — Horizontal frequency will not lock, and vertical sometimes rolls.
Cure — Check XT700 by replacement; it might be open.

Chassis — Sylvania E32
PHOTOFACT — 2034-1

3

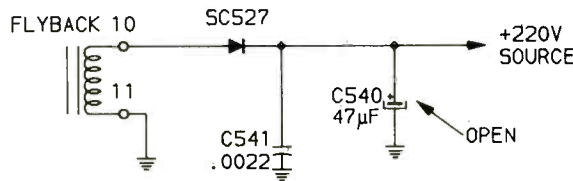

Symptom — Picture is too bright with smeared video, and the screen is darker on one side.
Cure — Check filter capacitor C540; replace if open.

Chassis — Sylvania E32
PHOTOFACT — 2034-1

4

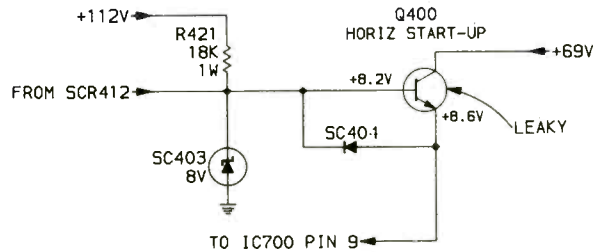

Symptom — One or two vertical black lines near center of the picture
Cure — Check Q400 out of circuit, and replace it if there is any leakage.

Chassis — Sylvania E32
PHOTOFACT — 2034-1

5

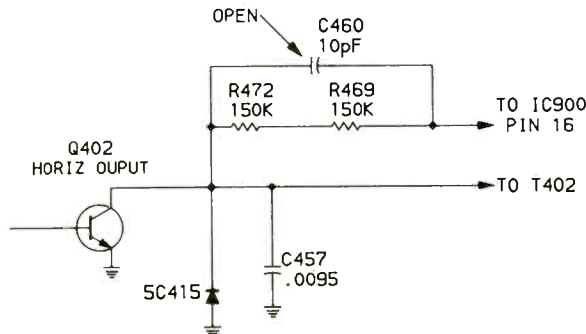

Symptom — Left side of the picture has no color.
Cure — Check capacitor C460 and replace it if open.

Chassis — Sylvania E32
PHOTOFACT — 2034-1

6

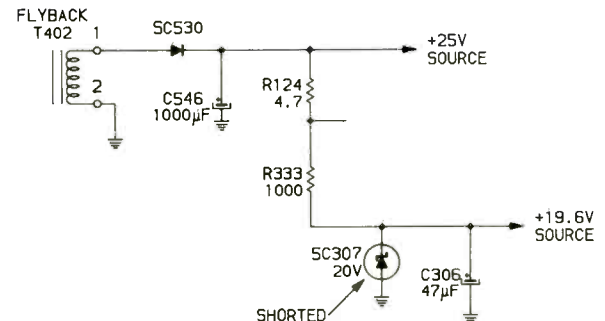

SYMPTOM — No sound (and no +19.6V source)
Cure — Check zener diode SC307 and replace it if shorted.

**Coming
in...**

JUNE

Watch for a new department—Audio corner, by Kirk Vistain, will address the pleasures (!) and problems peculiar to servicing audio electronics equipment. In June, Vistain questions the credibility of using specifications as advertising tools to beef up sales of amps and other audio gear, and discusses those specifications that are meaningful numbers and not just hype.

Digital scopes make troubleshooting easier—ES&T's Technology department brings you the facts about a high-tech oscilloscope that is expensive for general use at the present time, but that should effect changes in scope design which ultimately will impact the servicing industry.

Dealing with multiple problems in a TV set—TV servicing problems compound; they cannot be summed by simple addition, or dispatched one-two-three. A second problem makes it several times harder to find even one source of trouble, much less two. Read how one longtime technician, Homer Davidson, copes with troubles that seem to multiply as they complicate testing.

Replacement parts—Identifying the malfunctioning component is only half the battle; where, oh! where is a suitable replacement? In this article, Conrad Persson gives some hints on recognizing components that are not readily identifiable, gives names and addresses of suppliers and recommends correct handling procedures.

Classified

Advertising rates in the Classified Section are 75 cents per word, each insertion, and must be accompanied by payment to insure publications.

Each initial or abbreviation counts a full word.

Minimum classified charge is \$15.00.

For ads on which replies are sent to us for forwarding (blind ads), there is an additional charge of \$25.00 per insertion to cover department number, processing of replies, and mailing costs.

Classified columns are not open to advertising of any products regularly produced by manufacturers unless used and no longer owned by the manufacturer or distributor.

FOR SALE

AUTOMOBILE RADIO and tape replacement parts. Delco, Chrysler, Philco-Ford, Motorola, Panasonic and many others. Large inventory. Laran Electronics, Inc., 3768 Boston Road, Bronx, NY 10469. (212) 881-9600. National (800) 223-8314, NY State (800) 446-4430. 1-85-tfn

BOOTLEGGERS BIBLE for CB Modification \$12.95, CB Radio Repair \$10.95. Linear Amplifier Planbook \$14.95, kits, etc. Catalog \$1.00 refundable—APS, POB 263 Newport, R.I. 02840 401-846-5627. 12-84-tfn

SCRAMBLED TELEVISION, encoding/decoding. New book. Theory/circuits, \$9.95 plus \$1 shipping. Workshop, Box 393ES, Dept. E, Bethpage, NY 11714. 1-85-tfn

TV TROUBLE ANALYSIS TIPS. Over 300 symptoms/remedies by circuit area; tough ones over the years. Save time and money. Send \$12.50 to CHAN TV, 8151 Grandview Rd., Chanhausen, MN 55317. 1-85-tfn

CABLE CONVERTERS. Lowest price. Dealer inquiries accepted. Quantity Discounts. FREE CATALOG. P.G., Video Corp, 61 Gatchell St., Dept. ES&T, Buffalo, NY 14212. 5-85-tfn

CABLE TV CONVERTERS & EQUIPMENT. Plans and parts. Build or buy. Send S.A.S.E. C&D Electronics, P.O. Box 1402, Dept. ES&T, Hope, Arkansas 71801. 1-86-tfn

CONVERT ANY SCOPE into a spectrum analyzer/receiver. Send stamp, self-addressed envelope for details. Workshop, Box 393ES, Bethpage, N.Y. 11714 03-86-3t

INDIVIDUAL PHOTOFACT FOLDERS (not sets) #1 to #1400, \$3.00 first-class postpaid. Loeb, 414 Chestnut Lane, East Meadow, NY 11554. 4-86-3t

REPAIR OF ZENITH CIRCUIT BOARD 9-160-ALL; with dud exchange \$33.00. One year guarantee. Kinirral Electronics, 68-26 64th Place, Glendale, N.Y. 11385. (718) 366-3859. 4-86-3t

LEARN BEGINNING, intermediate, or advanced electronics. Also computer electronics and micro-interfacing courses. Excellent home study program. Only 39.00 per course. Write: IOTS/LS, Box 536, Rantoul, Ill. 61866. 5-86-1t

ATARI 520ST Computer Schematic Sets, complete, now available only \$10.00 each. Free Shipping. Call (805) 927-4667 VISA/MC/COD or Send to Electronic Dimensions, P.O. Box 1846, San Luis Obispo, CA 93406. 5-86-1t

TV TROUBLESHOOTING: Over 100 ILLUSTRATED problems-solutions of difficult repairs. Also, 12 steps to easier TV repair, \$12.00. REMARKABLE DIAGNOSTIC TOOL: Determine operation of high voltage circuits every time. You will not be mistaken about your conclusions, \$5.00. Jones, Box 702, Niceville, Fla. 32578. 5-86-6t

BUSINESS OPPORTUNITIES

FT. LAUDERDALE. Diversified electronic business located in busy shopping center. Old established with steady clientele. Reasonably priced for quick sale. \$85,000. Call 305-776-4941. 4-86-2t

ELECTRONICS REPAIR SHOP. TV, stereo, VCR, microwave repair. Established 10 years in Wichita. \$20,000. Will trade. Eugene Faber, 2527 W. Pawnee, Wichita, KS 67213. 4-86-2t

3 HRS FROM SAN FRANCISCO in pine forested foothills, electronic repair business. Poor health forces sale. Bldg./shop/equipment. & 7 rm. residence w/lg. garden, was \$165K, now \$155K. (916) 872-1962. 12/85tfn

TV SALES, SERVICE & RENTAL business in Sealde, Calif. Same location 26 years, \$40,000. 408-394-5949 or 394-7928. 5-86-1t

FOR SALE—GKW Electronics Inc. TV sales and Service Co. Lahaina, Maui-HI 96761—Gross Income yr. \$750,000—Price 150,000. 3000 TV sets under multi-year warranty, contracts. For more information write/phone 1-808-661 8120/0806, Robert P. Giso, Pres. Mgr. 5-86-1t

TV REPAIR SHOP, equipment, stock, van \$20,000. Located in downtown Bradenton, FL. Authorized dealer for major companies. Phone (813) 795-2786. 5-86-1t

TV/VCR/STEREO SERVICE BUSINESS. Lucrative used set sales. Est. 10 yrs. Gross \$87,000. Located in Ojai, Ca. area, 10 minutes to ocean, 5 minutes to lake. Asking \$18,000. George's TV, 805/649-9758. 5-86-1t

ELECTRONIC SERVICING & TECHNOLOGY Volume 6, No. 5 (USPS 462-050) is published monthly by Intertec Publishing Corp., 9221 Quivira Road, P.O. Box 12901, Overland Park, KS 66212. Second Class Postage paid at Shawnee Mission, KS, and additional mailing offices. POSTMASTER: Send address changes to ELECTRONIC SERVICING & TECHNOLOGY, P.O. Box 12952, Overland Park, KS 66212-9981.

HELP WANTED

CAMERA-VIDEO Technicians needed. Top pay and benefits for well trained and experienced technicians who are expert with consumer and/or industrial cameras and VCR's. Training by manufacturers such as Sony, Hitachi, Panasonic, etc., are necessary for job experience. Come to sunny Florida and enjoy your work & leisure time. Write or call ATLANTIC ELECTRONICS INC., 1881 NE 26 St., Ft. Lauderdale, FL 33305. (305) 564-8274 10 AM to 6:30 PM. Ask for Dave or Joe. 8-85-tfn

TELEVISION TECHNICIAN NEEDED. Must be experienced with American & Japanese televisions. Excellent benefit package and incentive plan. Send resume to P.O. Box 894, Union, N.J. 07083. 4-86-2t

EDUC.-INSTRUCTION

UNIVERSITY DEGREES- Economical home study for Bachelor's, Master's, Doctorate, Prestigious faculty counsels for independent study and life experience credits. Free information—Richard Crews, M.D. (Harvard), President, Columbia Pacific University, 1415 Third St., Dept. 2B85, San Rafael, CA 94901; Toll Free: 800/227-0119; California: 800/552-5522; or 415/459-1650. 5-86-1t

ELECTRONIC TECHNICIANS AVAILABLE: The Willmar Area Vocational-Technical Institute will graduate Electronic Service Technicians in June, 1986. Graduates have received training in consumer electronic equipment, such as VCR's, satellite television, and television receivers. In addition, the graduates have received the PACE training program on soldering and PC board repair. Their training involves hands-on experience of analyzing and troubleshooting, and repairing microcomputers, disk drives, printers, and video monitors. Training covers operation of recent model personal computers, microprocessors, digital electronics, data communications systems, and BASIC programming. For further information, contact Fred Hanson, Placement Coordinator, Willmar AVTI, P.O. Box 1097, Willmar, MN 56201, telephone (612) 235-5114, extension 118. 4-86-2t



"Tech's Guide To Pricing"
updated new 5th edition...a framework for setting rates that apply to hi-Tech products...a formula that guarantees SUCCESS!
Call Toll Free for details
1-800-228-4338 8/5 CST

Circle (19) on Reply Card

PERSONALIZED 24-HOUR SERVICE ON OVER 7,000 ELECTRONIC COMPONENTS & PRODUCTS...

CALL TOLL FREE
1-800-558-9572 IN WIS 1-800-242-9553

PRB
PROJECTOR RECORDER BELT
200 Clay Street • Whitewater, WI 53190
TLX 4994411 PRBUSA

Circle (20) on Reply Card

ATTENTION ELECTRONIC TECHNICIANS



Highly Effective Home Study BSEE Degree Program for Experienced Electronic Technicians
Our New Advanced Placement Program grants Credit for previous Schooling & Professional Experience. Advance Rapidly! Our 40th Year!
FREE DESCRIPTIVE LITERATURE!
Cook's Institute of Electronics Engineering
P.O. BOX 20345, JACKSON, MS 39209

Circle (21) on Reply Card

Advertisers' Index

	Page Number	Reader Service Number	Advertiser Hotline
Automated Production Equipment Corp.	53	16	516/654-1197
B&K Precision Dynascan Corp.	47	14	312/889-9087
Beckman Industrial Corp.	IFC	1	714/671-4800
Cleveland Institute of Electronics	12A,12B		800/321-2155
Cleveland Institute of Electronics	13	7	800/321-2155
Cooks Inst., Elec. Engrg.	64	21	601/371-1351
Cooper Group	1		919/362-7510
Dandy Mfg. Co.	64	22	800/331-9658
Diehl Engineering	7,9,11	6	806/359-0329
ETA	51		
Fluke, John Mfg. Co., Inc.	5	5	800/227-3800
Iwatsu Instruments	15	8	201/935-5220
Management Insight	64	24	813/792-3804
NESDA	57,59		817/921-9061
Nippon American Inc.	53	15	800/327-7522
NTE Electronics, Inc.	16,17	9	800/631-1250
Optima Electronics	57	17	800/327-0224
Precision Picture Tubes	64	23	716/621-5250
Prentice-Hall Inc.	3	4	
Projector Recorder Belt Corp.	64	20	800/558-9572
Sencore, Inc.	38,39	10,11	800/843-3338
Sencore, Inc.	40,41	12,13	800/843-3338
Sperry AW Instruments Inc.	IBC	2	800/645-5398
Sperry Tech, Inc.	64	19	800/228-4338
Tentel	51	18	800/538-6894
Unity Electronics	64	25	201/351-4200
Zenith	BAC		

**NATIONAL REBUILT HEADQ. FOR—
SONY REBUILT
PICTURE TUBES**
2 YR. WARR. — FREE U.P.S.-DEL.
716-621-5250

Circle (23) on Reply Card

ATTN. SERVICE SHOP OWNERS
Are you serious about improving your operation? We offer workable solutions from one of the most respected service management consultants. 16 years of professional experience solving the problems for major companies.

MANAGEMENT INSIGHT
R. J. SEBRING
4511 17TH AVE. W.
BRADENTON, FL 33529
(813) 792-3804

Circle (24) on Reply Card

NEW 20-PAGE CATALOG FREE

7 MILLION TUBES
Includes all current, obsolete, antique, hard-to-find receiving, transmitting, industrial, radio/TV types. **LOWEST PRICES.** Major brands in stock.
Unity Electronics Dept. E
P.O. Box 213, Elizabeth, N.J. 07206



Circle (25) on Reply Card

DANDY-DAPTER™

PATENTED CRT ADAPTER—Don't buy another socket for your CRT Tester! This is the **Only** way you can win the Socket War! Guaranteed to fit your tester & allow you to test/clean/restore ANY Color, B/W, Projection, Scope or Camera CRTs. Visa/M-Card, Checks, CODs. New Low Price \$59.95 (We pay UPS) 1(800) 331-9658. DANDY ELECTRONICS, 2323 GIBSON, MUSKOGEE, OK 74403.



Circle (22) on Reply Card

AWS TEST INSTRUMENTS



DML-4020 DATA LOGGING DMM

This microprocessor controlled portable instrument contains two autoranging digital multimeters, four comparators, one timer and a 2 inch dotmatrix printer. Both DMM's may be used individually or simultaneously to measure and record all functions. The dot matrix printer provides numerical or graphic printouts displaying sampled values at pre-selected automatic or manual time intervals. The recordings end with a calculation of lowest/highest values, number of sample intervals and calculated average. Comparator output signals are available for actuating external equipment. \$1,000.00.

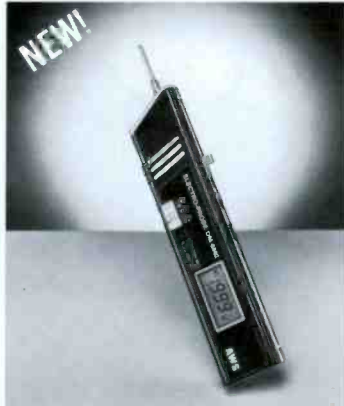

DM-6592 ELECTRO-PROBE™ DMM

One of the smallest, most convenient hand-held DMM's you'll ever own. It's both autoranging and manual and is the perfect instrument for taking readings easily and accurately in hard to reach areas. Other features include instant audible continuity buzzer; one-hand operation; electronic overload protection on all ranges; data-hold button. **Ranges:** 0-200m/2/20/200/500Vdc; 0-2/20/200/500Vac; 0-200/2K/20K/200K/2000K/20MΩ. \$55.00.



DM-7010 4 1/2 DIGIT ROTARY SWITCH DMM

High accuracy readings in the laboratory or in the field. Features include 4 1/2 digit 19999 max. display; built-in frequency counter to 200KHz and conductance function; 0.05% basic dc volts accuracy; overload protection on all ranges; special electronic protection to 250Vac/dc on resistance ranges; UL1244 type test leads; diode and continuity tests; **Ranges:** 0-200m/2/20/200/1000Vdc; 0-200m/2/20/200/750Vac; 0-200μ/2m/20m/200m/2/10Aac/dc; 0-200/2K/20K/200K/2M/20MΩ; 0-200nS conductance; 0-20K/200KHz frequency. \$170.00.



DM-1 POCKET-PRO™ DMM

Big features are packed in this pocket-calculator sized DMM. You'll find autoranging; electronic overload protection on all ranges; auto-polarity; audible and visual continuity indication; built-in test leads; "booklet-type" carrying case is designed to fit easily in shirt pocket. **Ranges:** 0-2000m/20/200/400Vac/dc; 0-200/2000/20K/200K/2000KΩ; 0-200Ω continuity. \$29.95.



BL-4 CLASSMATE DIGITAL BREADBOARD LAB

Nicknamed "The Instructor's Best Friend", this completely self-contained classroom lab combines a breadboard, DC power supply (fixed and variable), signal generator (sine, triangle and square wave outputs), digital voltmeter, 8-bit LED display, BCD to 7 segment decoder and display, flip-flop gate and logic switches in one compact unit. The BL-4 is only 11" x 13" leaving more work station area free for other instructional materials and requires only one electrical outlet. \$349.95.

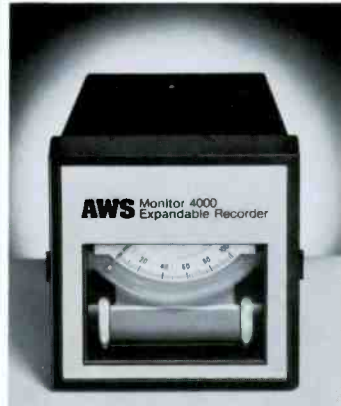

MONITOR 4000 EXPANDABLE RECORDING SYSTEM

The new recording system that can be expanded on as needed. Start with the XR-4000 basic 3 speed recorder, add any of five volt/amp or temperature modules, then select any of five transducers for easy current or temperature measurements. The XR-4000 can be panel mounted, used on a bench top or as a portable in its functionally designed carrying case. Basic XR-4000 3 speed recorder \$229.95. Complete kits start at \$399.95 and include XR-4000, module, transducer, carrying case, chart paper, tilt stand.



DM-3000 3 1/2 DIGIT ROTARY SWITCH DMM

Just one of three DMM's in our Economy Series that combines quality with economy. Features include built-in HFE, battery and diode testing; conductance function; 300 hour battery life; 10Aac range; electronic overload protection on all resistance ranges; pocket-sized. (Also available models DM-1000 & 2000). **Ranges:** 0-200m/2/20/200/1000Vdc; 0-200m/2/20/200/750Vac; 0-200μ/2m/20m/200m/10Aac/dc; 0-200/2K/20K/200K/2M/20MΩ; 1.5V battery test; 0-1000 Hfe test; 2KΩ diode test. DM-1000: \$39.95 / DM-2000: \$54.95 / DM-3000: \$69.95.



SP-5 POCKET-SIZE MULTIMETER

An unbelievable \$9.95 buys you this small yet suprisingly rugged multimeter. Perfect for the professional, homeowner and hobbyist. Its big features include safety recessed test lead connections; high impact ABS plastic case; mirrored scale plate; diode protected meter movement; uses only one 1.5V AA battery. **Ranges:** 0-10/50/250/500Vac/dc; 0-0.5/50/250mAdc; 0-1MΩ (5KΩ mid-scale); -20 to +56db. \$9.95.

A.W. SPERRY INSTRUMENTS INC.

For more information see your local distributor or contact A.W. Sperry Instruments Inc.
245 Marcus Blvd., Hauppauge, N.Y. 11788 • 800-645-5398 Toll-Free (N.Y. and Alaska call collect 516-231-7050).

See us at the EDS - Booth #F-18

Circle (2) on Reply Card



DEALER INQUIRIES INVITED

The easiest, fastest, most rewarding way for you to make it big – or even bigger! – in consumer electronics is usually with name brand products.

The better known a product, the easier, faster and the more profitably it can be sold. Consider the case of Zenith Accessories.

In a name recognition study conducted recently among end-users, the Zenith name and logo scored as the best known and the most readily recognized of all the brand names in consumer electronics.

That's why you should be carrying and cashing-in on Zenith Accessories.

Zenith Accessories, like all Zenith products, must meet or exceed Zenith's quality and performance standards. It is standards like these that have earned Zenith a level of acceptance unsurpassed in consumer electronics.

Call your Zenith distributor's Accessory Sales Manager and learn now – today! – how to turn some 6, 7 or 8 feet of your floor space into a new Zenith Profit Center. With the selling power of Zenith Electronic Accessories, of course.

Or write direct, if you prefer, for the name of your Zenith distributor.

Zenith Service, Parts & Accessories, Dept. 24
11000 Seymour Avenue, Franklin Park, Illinois 60131

ZENITH
The quality goes in before the name goes on.®